

"(c) 2017 IEEE. Personal use of this material is permitted. Permission from IEEE must be obtained for all other users, including reprinting/ republishing this material for advertising or promotional purposes, creating new collective works for resale or redistribution to servers or lists, or reuse of any copyrighted components of this work in other works."

# Towards a Plant Bio-Machine

Stefano Nichele\*, Sebastian Risi†, Gunnar Tufte‡, Laura Beloff†

\*Oslo and Akershus University College of Applied Sciences, Oslo, Norway, stefano.nichele@hioa.no

†IT University of Copenhagen, Copenhagen, Danmark, {sebr, lbl}@itu.dk

‡Norwegian University of Science and Technology, Trondheim, Norway, gunnar.tufte@ntnu.no

**Abstract**—Plants are very efficient computing machines. They are able to sense diverse environmental conditions and quickly react through chemical and electrical signaling. In this paper, we present an interface between plants and machines (a cybernetic plant), with the goal of augmenting the capabilities of plants towards the creation of plant biosensors. We implement a data acquisition system able to stimulate the plant through different electrical signals, as well as record the electrical activity of plants in response to changing electrical stimulations, light conditions, and chemicals. The results serve as a proof of concept that sensing capabilities of plants are a viable option for the development of plant bio-machines. Different future scenarios (some speculative) are discussed. The work herein is carried out as a collaboration between the EU project Flora Robotica and the EU project NASCENCE.

## I. INTRODUCTION

As all living beings, plants are remarkable living "machines". They are able to manifest complex computing functions such as metabolism, growth, self-reproduction, and adaption to external (environmental) as well as internal (physiological) stimulation.

In the recent years, intense yet non-conclusive research has been conducted in the field of plant intelligence [1]–[3]. Plant tissues and cells sense and communicate through "slow" chemical signals and "fast" electrical signals. Plant action potentials (APs) were discovered as early as in 1872 [4], [5], due to depolarisation of plasma membrane [6]. More recent studies have elucidated the basic concepts of energetics, electrophysiology, and photobiophysics of green plants [7]. This trend was motivated by the possibility of interfacing plants to electronic components in order to utilise their intrinsic sensing capabilities as biosensing devices [8]. The preliminary work herein establishes a hardware/software interface for simple plant electrical activity recording and stimulation through diverse stimuli, e.g., current, light, etc.. This work paves the way towards the implementation of plant bio-machines.

This paper is laid out as follows: Section II gives background information on plant physiology, and relevant research projects dealing with computation in unconventional materials as well as symbiotic robot-plant societies. Section III describes the research motivation and the experimental setup. Section IV outlines the preliminary results and Section V concludes the work with a discussion of possible future work and future scenarios of application (some speculative).

## II. BACKGROUND

### A. Plant Physiology

A novel plant biology research stream, i.e. plant neurobiology, has recently gained momentum. The main goal of plants neurobiology is to understand how plants process information. Plants are subject to diverse environmental stimuli and are able to process them and produce a wide variety of responses, i.e. through signaling systems. Such signaling mechanisms include production of chemicals as well as long-distance electrical signals, i.e., action potentials (APs) and variation potentials (VPs), as result of temporary depolarization of membrane potential [9]. Another type of signal is local electrical potential (LEP), which is responsible for communication which does not propagate over long distances [10]. Typically, VPs are produced by damaging stimuli whether APs are the result of non-damaging stimuli. APs have been reported and measured in *Mimosa pudica* [6] and *Venus flytrap* [4]. For a more comprehensive introduction to plant electrical signaling see [11]. Even if such communication and signaling mechanisms have been observed and (to some extent) reproduced, a clear understanding of the relation between electrical signals, type of responses and organs involved is still an open question. Plants show a wide variety of autonomous behaviors, such as when and where to forage for nutrients, when and what organs to generate, when to reproduce, how to protect from attacks, when and where to transmit chemicals to the environment and neighboring organisms; all in a changing environment (e.g. light, weather, wind, rain, temperature, etc.). Such abilities to adapt and self-organise are the result of a sophisticated information storage, acquisition system, and processing capabilities.

Electrical signals are considered the most important physical signals in plants, because of the ability to transfer information over long distances faster than by chemical signals [12]. Extracellular measurements of electrical signals in plants are typically performed by surface contact electrodes or needle electrodes. While surface electrodes are suited for short term usage (due to drying of electrode medium), needle electrodes inserted into the plant tissue are applicable for long-term testing (but they may cause some wounding). Other types of stimulation have been investigated. In [13] light has been used to trigger bioelectrical activity.

In [14], it was observed that an induced electrical stimulus between a midrib and a lobe of Venus flytrap closed the

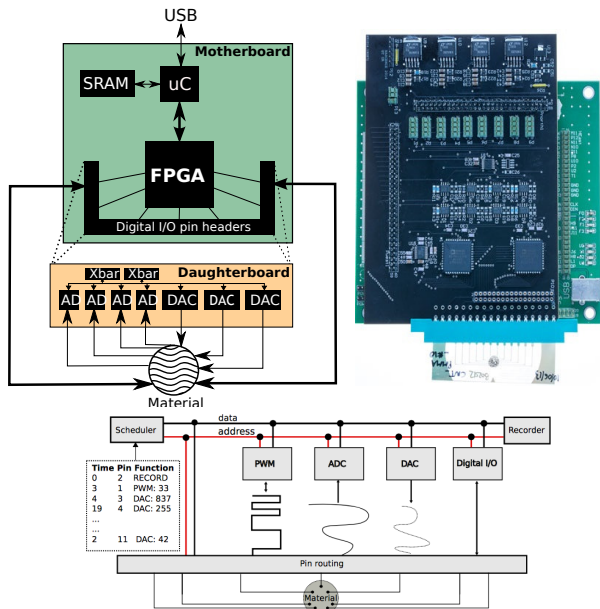

Fig. 1: Mecobo setup and schematic overview.

leaf by activating motor cells without mechanical stimulation of trigger hairs. In particular, the used electrostimulation consisted in a 1.5 V AP for a duration of 1 second, which resulted in a closing time of 0.3 seconds, consistent with a natural mechanically induced closing. It was reported that the resulting AP in the plant had a duration of 1.5 ms.

Although the plant "nerve-like system" does not develop to the same degree of complexity as in animals, it is evident that it is able of remarkable long-distance signaling. A summary of physiological effects of electrical signals in plants is presented in [9].

In [8] it has been proposed that plants could be used as biosensors, i.e., devices that could detect changes in a biological system, for monitoring of atmospheric electrochemistry, acid rain, pesticides, light, and pollutants. As an example, they reported APs in potato plants and soybean when different environmental conditions were produced. A more recent study [15] reported different electrical circuits in plants, including capacitors, resistors, inductors and memristors, which contribute to processing and decision making (memory).

A related research effort [16] is investigating how to produce wires from living plants and the evolution of logic gates using an evolution-in-materio paradigm [17].

Such research field has both theoretical as well as practical implications. Understanding the processing mechanisms in plants would result in novel technologies and natural biosensors, towards an understanding of plant "intelligence". This could lead to the creation of hybrid bio-machines. Such work requires a multi-disciplinary effort, at the intersection of ICT and bioelectrochemistry.

### B. Computation in Physical Materials

Evolution-in-materio (EIM) [18], [19] is a relatively new field of research that explores physical materials to perform

computation. Such emergent computation is exploited by manipulating the materials via computer-controlled evolution (CCE). CCE may program the materials with different kinds of stimuli, e.g. voltages, currents, temperature, light, etc. The chosen substrate is treated as a *black box*, i.e. some input signal is encoded in the substrate and some output signal is decoded from it. Examples of exploited substrates include ferrous sulphate solutions [20], FPGAs [21], liquid crystals [22], carbon nanotubes [23], biological neurons [24], slime mould [25], and cellular automata [26]. In particular, the EU-funded project Nascence has produced a wide variety of computational devices in unconventional substrates. For a detailed explanation of recent efforts in the Nascence project see [18], [27]. One of the results of the Nascence project is the Mecobo evolutionary motherboard [28], depicted in Figure 1.

The Mecobo board is a custom-built hardware interface between the substrate and a traditional computer. All the input signals and output measurements are carried out through the Mecobo board, which offers the possibility of mixed signals, i.e. digital and analogue, input/output setup on any of the 16 available electrodes. All the experiments in this paper are carried out through the Mecobo board.

Plants are very complex computing substrates and therefore may be interfaced with Mecobo for stimulation and electrical recordings, towards a hybrid plant-bio machine.

### C. Symbiotic Robot-Plant Societies

While the main motivation for artificial life research is to investigate life-as-it-could-be, another important research direction is to study *mixed societies* of biological organisms interacting with artificial life artefacts. The aim of such novel research direction is to gain a better understanding of emergent behaviors, interactions and communications between artificial and biological life-forms. The EU funded project Flora Robotica [29] aims at studying mixed societies of symbiotic robot-plant bio-hybrids, both in the physical world as well as in simulation [30].

In this paper, the main motivation is to investigate plants' ability as bio-sensors, towards a better understanding of plant intelligence and hybrid plant-machines.

## III. RESEARCH MOTIVATION AND EXPERIMENTAL SETUP

The research described in this paper aims at establishing a simple plant-machine interface in order to carry out stimulations and recordings of plant electrical activity under varying environmental conditions. The long-term goals are to investigate the possibility of using plants as bio-sensors as well as a better understanding of plant signaling and information processing. Such processing capabilities may be used in the future to exploit plant intelligence for control of hybrid bio-machines and plant-robots.

Two types of plants are purchased and cultivated in the Robotics, Evolution and Art Lab (REAL) at IT University Copenhagen, Denmark. The first type of plant is Aloe Vera (*Aloe*) and the second type of plant is Echeveria Suculentus (*Crassulacae*). Both plants have a diameter of 11cm and thick

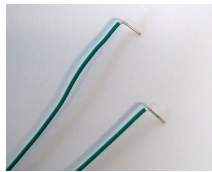

Fig. 2: Needle-type conductive electrodes.



Fig. 5: LED growing light bulb.



(a) Aloe Vera.

(b) Echeveria Suculentus.

Fig. 3: The two used plants in the faraday cage with connected electrodes.



(a) Setup with light off.

(b) Setup with light on.

Fig. 6: Setup with different light conditions.

leaves that provide appropriate surfaces for securing needle-type electrodes. Electrodes are inserted in random positions, avoiding to position electrodes too close to each other in order to avoid direct contact between them. Figure 2 shows the needle-type electrodes and Figures 3a and 3b depict the electrodes inserted into the Aloe and Echeveria plants, respectively.

Both plants have been positioned into a carton box covered with aluminium foil (i.e. a Faraday cage) to shield any external electromagnetic noise. In order to verify that no external noise is received inside the box, one electrode is left disconnected

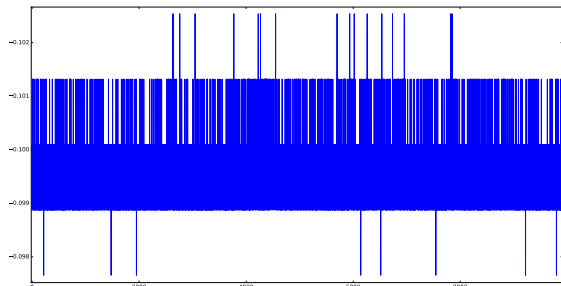

Fig. 4: Control signal in Faraday cage, 1 disconnected electrode recorded for 1 second at 10kHz, peak-to-peak variation of 0.004V (negligible noise). x axis represents time and y axis represents voltage amplitude.

and the corresponding signal is recorded through Mecobo for 1 second at a sampling rate of 10kHz. The plot is shown in Figure 4, where the peak-to-peak variation measured is negligible (0.004V).

In addition, a 3W growing light with 36 LEDs (20 red and 16 blue) is inserted into the plant box. An image of the growing light bulb is shown in Figure 5. Figures 6a and 6b depict the setup with light off and on, respectively (with box open in order to allow for pictures, however the box was closed during the experimental work).

An additional setup was attempted with a Basil plant (*Lamiaceae*). However the leaves proved to be too fragile for needle-like electrodes (see Figure 7). For this kind of plants, surface-



(a) Mecobo board connected to (b) Basil and needle electrodes Basil plant setup.

Fig. 7: Mecobo board setup for the unsuccessful Basil experiments.

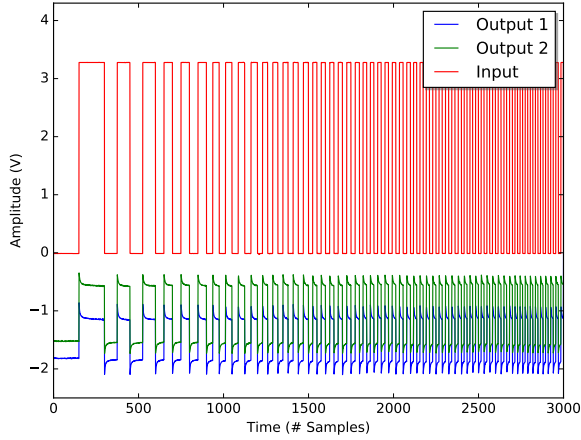

(a) Aloe Vera frequency sweep (100-1000Hz) in darkness.

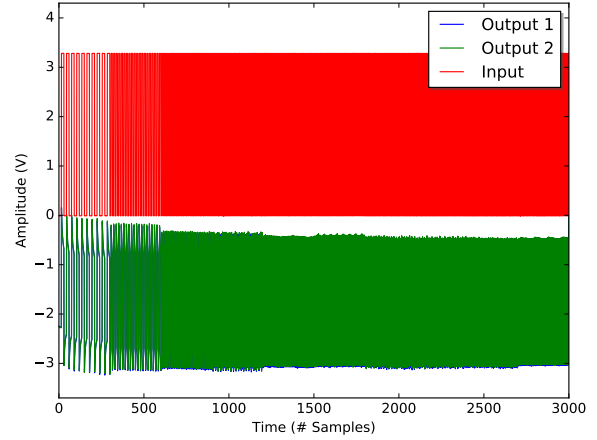

(a) Echeveria frequency sweep (1000-10000Hz) in darkness.

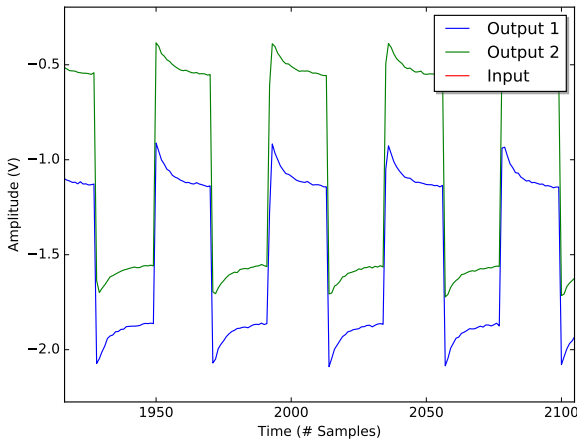

(b) Zoom-in results.

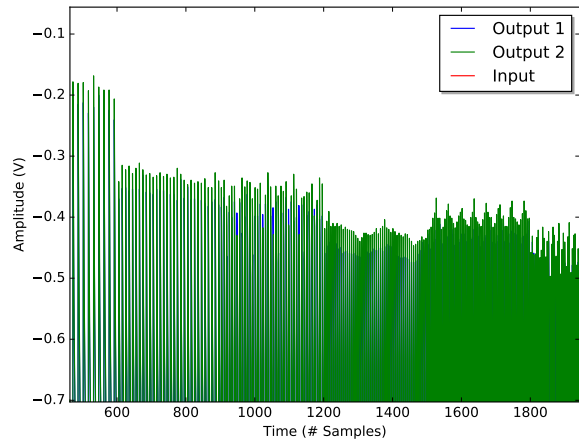

(b) Zoom-in results.

Fig. 8: Results of Aloe Vera frequency sweep in darkness.

Fig. 9: Results of Echeveria frequency sweep in darkness.

type electrodes (e.g. Electromyography electrodes) may be better suited.

As plants are known to possess diurnal/nocturnal cycles, all experiments are started with the same initial conditions, with the plant left in darkness for a period of 15 minutes. All experiments are conducted in the same room, with a temperature of around 22 degrees Celsius and humidity of around 50-55%. The used needle-type electrodes are made of copper with a length of 1cm.

#### IV. PRELIMINARY RESULTS

The first experiment consisted in recording the electrical activity of Aloe Vera in darkness while a square wave signal was used as stimulation. As discussed earlier, the plant was placed into a Faraday cage. Pin 0 of the Mecobo board was connected to the first electrode and set to ground (reference electrode). Pin 3 of the Mecobo board was connected to a second electrode and set to a square wave with 50% duty cycle, amplitude between 0V and 3.3V, and frequency

between 100Hz and 1000Hz. As such, a frequency sweep was conducted for a duration of 100ms. Pin 1 and 2 from the Mecobo board were connected to two different electrodes placed into two different areas of the plant, and designated as recoding pins at a sampling rate of 30000Hz. As such, 3000 samples were collected in total for each recording pin. Figure 8a shows the original signal in red as well as the recorded signals in green and blue. It is possible to notice that the amplitude of the output signal is not influenced by the input frequency. However, it is clearly visible that the amplitudes on the two output pins are fairly different. Another visible effect in the zoomed-in Figure 8b is the discharge and charge cycles produced by the plant.

The second experiment consisted in reproducing the exact same setup as the first experiment, using the Echeveria plant. The only difference is the used input frequency on pin 3, which is increased to the range between 1000Hz and 10000Hz. Figure 9a shows the original signal in red and the recorded signals in blue and green (the blue signal is not clearly

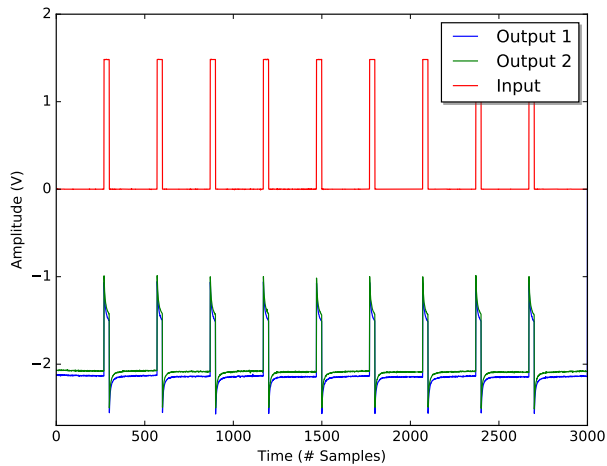
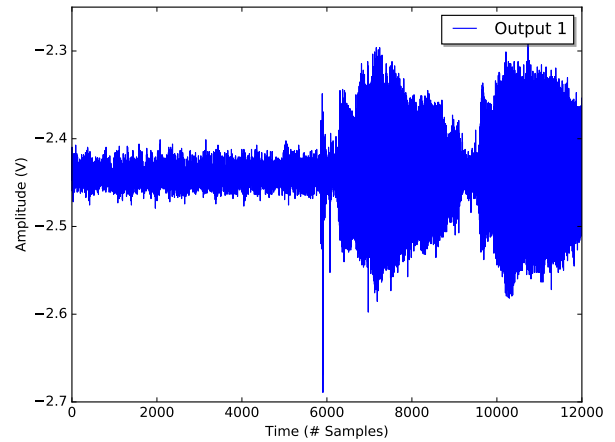

Fig. 10: Echeveria action potentials in darkness.

visible as it is fairly overlapping with the green signal). It is possible to notice that the output amplitude is a result of the input frequency. This is even more visible in the zoomed-in Figure 9b, where it is possible to detect different amplitudes for different input frequencies and repeating cycles (peaks) within the same frequency cycles. It is therefore plausible that the used plant is sensitive and responsive to specific frequency ranges (i.e. filter).

An additional third experiment is carried out using Echeveria. In this experiment, the input signal was connected to pin 7 of the Mecobo board. The input electrode was set to a static signal of 0V for 9ms and a static signal of 1.5V for 1ms. The same input was repeated 10 times, for a total experimental time of 100ms. Pin 0 was set to ground. The output signal was once again recorded on pin 1 and 2 with a sampling rate of 30000Hz, producing a total of 3000 samples. Figure 10 shows the input signal in red and the output signals in blue and green. It is possible to notice that the recorded output from the plant corresponds to a sequence of 10 action potentials (APs).

In the fourth experiment, the Echeveria plant was not connected to any electrical input signal. The plant, which was placed into the Faraday cage, was connected to one output electrode corresponding to pin 4 of the Mecobo board. The output signal was recorded for a period of 2 minutes at a sampling rate of 100Hz, for a total of 12000 samples. For the first 60 seconds, the plant was left in complete darkness. For the next 60 seconds, the growing light was turned on. The experiment was repeated a second time, after the plant was left in darkness for a period of 15 minutes. Figures 11a and 11b show the recordings of the two experimental runs. In both cases, it is clearly noticeable when the light is turned on, around sample 6000, as the amplitude increases. However, in the first experiment, while the light is left on for 1 minute, there are two visible cycles which the plant undergoes. Such electrical behavior is a result of the plant sensing the light (and the consequent electrochemical processes). In the second



(a) Run #1.

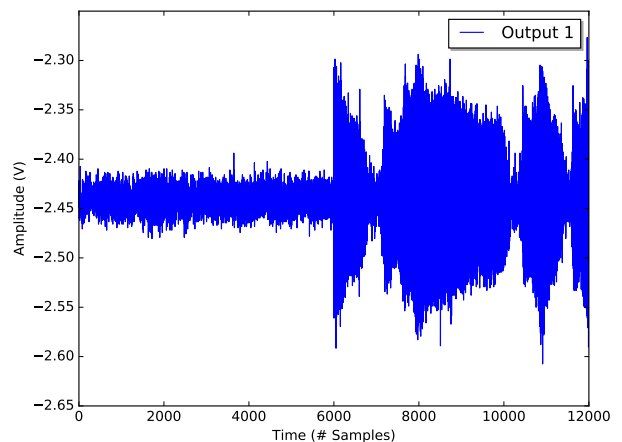

(b) Run #2.

Fig. 11: Echeveria light off 1min and on 1min, 2 different examples.

experimental run, it is possible to notice that the recorded patterns are different, showing electrical cycles of different duration. The recorded plant electrical activity behavior makes it possible to use the plant itself as a light sensor without the need of additional hardware, besides the electrode and the equipment used for electrical recording.

The same experiment was repeated for the Aloe Vera plant, with the same experimental setup. The recording is shown in Figure 12. In this case, it is again clearly visible when the light is turned on and the recorded amplitude increases. However, no clear electrical pattern is recognisable. It is therefore clear that the two used plants have different electrical signaling as resulting effect of light stimulation.

Two final experiments were carried out, one on each of the two plants. Echeveria was connected to two electrodes, one used as reference electrode (ground) and one used as recording pin for 10 minutes at a sampling rate of 100Hz, for a total of approximately 60000 samples. After 2 minutes,

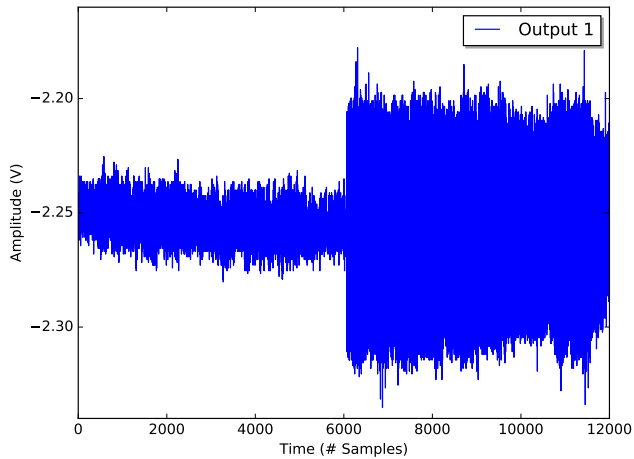

Fig. 12: Aloe Vera light off 1min and on 1min.

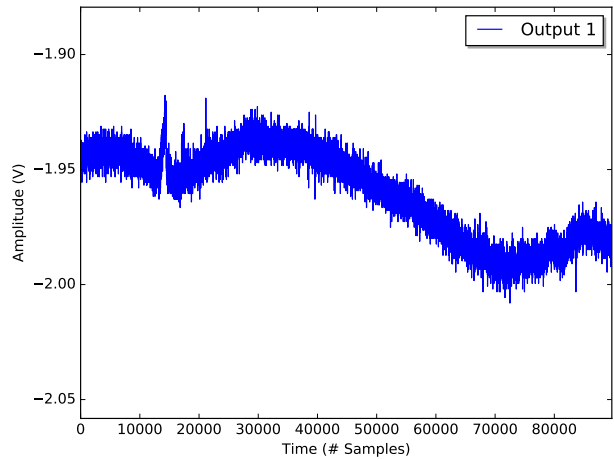

Fig. 14: Aloe Vera with addition of Decanoic Acid.

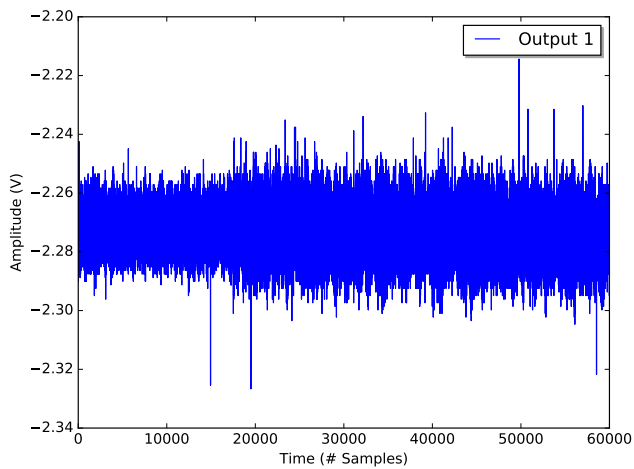

Fig. 13: Echeveria with addition of NaCl salt.

9ml of NaCl (Sodium Chloride) 3,5M was injected into the soil with a pipette. This scenario was intended to reproduce a salty soil sensor. While the electrical results do not show a drastic amplitude increase, it is still possible to notice a slight increase at around 3 minutes, where the signal becomes more noisy and with higher peaks. This effect is visible throughout the recording. Results are shown in Figure 13. Note that this experiment was conducted outside the shielded cage and in normal daylight.

The same way, Aloe Vera was also connected to one reference electrode and one output electrode. The recording was carried out for 15 minutes. After two minutes, 6ml of Decanoic Acid 10M was injected into the soil with a pipette. This scenario was intended to reproduce an acid rain sensor. Figure 14 shows the recorded results. Note that this experiment was conducted outside the shielded cage and in normal daylight. After about two minutes, a sharp spike is clearly visible, which

corresponds to the moment when the acid solution has reached the plant. This is an indication of the electrical behavior in acid conditions. Afterwards, there is an increase and then a decrease in recorded amplitude.

The presented results are somewhat consistent with the results documented by the EU Project PLEASSED [31], using different types of plants, equipment and recording procedures. Different plants have been shown to be capable of reacting to changing environmental conditions through different kinds of electrical patterns. As such, it is possible to envision future applications where plants are used as bio-sensors. However, at the current state of research, the process of setting up the correct number of electrodes and electrical signals is not automated.

#### A. Unsuccessful Experimentation

A set of unsuccessful tests is briefly reported here. The experimental setup presented in [32] was attempted under different light conditions, with the difference that the used plant was placed inside a Faraday cage. No variation of reported output frequency was found. It is therefore plausible that the results reported in [32] are the result of environmental/electromagnetic noise (as the plant was not shielded).

As reported in [17], where an exhaustive search for logic gates was reported, the usage of evolutionary search for *configuring* the plant for specific computation would be beneficial. For this purpose, an evolved frequency classifier was attempted with the methodology reported in [33]. However, no feasible solution was successfully evolved. More experimentation is therefore needed to assess the feasibility of using evolutionary search in plant substrates.

## V. DISCUSSION AND CONCLUSION

In this paper, we have outlined a simple experimental setup for hybrid plant-machines and documented preliminary results of plant biosensing computations. More experimental work is needed to establish a working prototype. However, the presented results show that electrical activity of plants may

be recorded and used as indication of different environmental conditions (e.g. changes in light, chemicals, electrical stimulation). Such plant behavior may be exploited for several applications. Here we outline some of the possible scenarios and fields of application (some speculative), ranging from robotics to agriculture, from sensing devices to computational substrates, and within art/architecture.

- Robotic bio-machine: since plants carry out some form of computation to react to diverse external conditions, such control system may be used as *controller* for a robotic bio-machine, where the plant itself works as its *brain*.
- Computing substrate: plants may be used as computing substrate using an evolution-in-materio paradigm, where artificial evolution is used as programming tool to identify suitable stimulations to configure and exploit the plant to carry out a sought computational function.
- Plant bio-sensors: one of the straight forward applications may be to utilize plant intelligence as bio-sensors. The results in this paper provide a proof-of-concept that such paradigm is within reach.
- Environment and pollution monitoring: one interesting application may be to use plants as monitoring devices for environmental pollution.
- Agriculture: another type of application may be certification of organic farming. Chemicals applied to plants may be detected by monitoring their electrical activity, as such, it may be possible to record the electrical activity of plants to certify their organic production.
- Plant acoustic: it has been shown that plants may react to acoustic signals [34], [35]. This kind of application may be utilized for agricultural purposes. An example is described in [36], where classical music is used as stimulation for producing wine grapes.
- Insects cooperation: plants have developed mechanisms to cooperate with other species, such as insects. An example is how caterpillar-damaged plants protect themselves by attracting parasitic wasps [37]. Such behavior may be studied and possibly controlled through electrical stimulation.
- Architecture and art: in [38] plants and technology are combined for artistic and architectural purposes, where plants rotate in order to achieve a microgravity environment. Robotic-plant systems in arts may be used for aesthetics as well as for raising awareness of themes around artificial life and interconnection between nature and technology.
- Studies of group of plants interaction: the experiments presented herein are a valuable tool for setting-up future studies of plant-to-plant and plant-to-mycelium communication, and for plant electrophysiological studies.

In conclusion, the study of hybrid plant bio-machines has great potential for future applications of artificial life and mixed societies of biological and artificial organisms, and may open the way to new engineering applications in diverse fields (e.g. bioelectronics, biocomputing, biomaterials). Our hope is

that the work herein will stimulate more and more research into this fascinating field.

#### ACKNOWLEDGMENT

The research leading to these results has received funding from the EU's 7th Framework Programme under grant agreement 317662 (Nascence project) and from the EU's Horizon 2020 research and innovation program under grant agreement 640959 (Flora Robotica project).

#### REFERENCES

- [1] A. Trewavas, "Aspects of plant intelligence," *Annals of Botany*, vol. 92, no. 1, pp. 1–20, 2003.
- [2] M. Szechyńska-Hebda, M. Lewandowska, and S. Karpinski, "Electrical signalling, photosynthesis and systemic acquired acclimation," *Frontiers in Physiology*, vol. 8, p. 684, 2017.
- [3] D. J. Poxson, M. Karady, R. Gabriëlsson, A. Y. Alkattan, A. Gustavsson, S. M. Doyle, S. Robert, K. Ljung, M. Grebe, D. T. Simon *et al.*, "Regulating plant physiology with organic electronics," *Proceedings of the National Academy of Sciences*, vol. 114, no. 18, pp. 4597–4602, 2017.
- [4] J. B. Sanderson, "Note on the electrical phenomena which accompany irritation of the leaf of *dionaea muscipula*," *Proceedings of the Royal Society of London*, vol. 21, no. 139-147, pp. 495–496, 1872.
- [5] C. Darwin, *Insectivorous plants*. J. Murray, 1888.
- [6] J. Fromm, "Control of phloem unloading by action potentials in *mimosa*," *Physiologia Plantarum*, vol. 83, no. 3, pp. 529–533, 1991.
- [7] O. S. Ksenzhek and A. G. Volkov, *Plant energetics*. Academic Press, 1998.
- [8] A. G. Volkov and D. R. A. Ranatunga, "Plants as environmental biosensors," *Plant signaling & behavior*, vol. 1, no. 3, pp. 105–115, 2006.
- [9] J. Fromm and S. Lautner, "Electrical signals and their physiological significance in plants," *Plant, Cell & Environment*, vol. 30, no. 3, pp. 249–257, 2007.
- [10] H. Ren, X. Wang, and C. Lou, "Über die ursachen elektrischen strome in pflanzen," *Journal of plant physiology and molecular biology*, vol. 19, no. 1, pp. 97–101, 1992.
- [11] E. D. Brenner, R. Stahlberg, S. Mancuso, J. Vivanco, F. Baluška, and E. Van Volkenburgh, "Plant neurobiology: an integrated view of plant signaling," *Trends in plant science*, vol. 11, no. 8, pp. 413–419, 2006.
- [12] X. Yan, Z. Wang, L. Huang, C. Wang, R. Hou, Z. Xu, and X. Qiao, "Research progress on electrical signals in higher plants," *Progress in Natural Science*, vol. 19, no. 5, pp. 531–541, 2009.
- [13] O. Haake, "The universal existence of electrical signals and its physiological effects in higher plants," *Flora*, vol. 75, no. 1, pp. 455–487, 1892.
- [14] A. G. Volkov, T. Adesina, and E. Jovanov, "Closing of venus flytrap by electrical stimulation of motor cells," *Plant signaling & behavior*, vol. 2, no. 3, pp. 139–145, 2007.
- [15] A. G. Volkov, "Biosensors, memristors and actuators in electrical networks of plants," *International Journal of Parallel, Emergent and Distributed Systems*, pp. 1–12, 2016.
- [16] A. Adamatzky, "Towards plant wires," *Biosystems*, vol. 122, pp. 1–6, 2014.
- [17] A. Adamatzky, S. Harding, V. Erokhin, R. Mayne, N. Gizzie, F. Baluska, S. Mancuso, and G. Sirakoulis, "Computers from plants we never made. speculations," *arXiv preprint arXiv:1702.08889*, 2017.
- [18] H. Broersma, J. F. Miller, and S. Nichele, "Computational matter: Evolving computational functions in nanoscale materials," in *Advances in Unconventional Computing*. Springer, 2017, pp. 397–428.



- [19] J. F. Miller and K. Downing, "Evolution in materio: Looking beyond the silicon box," in *Evolvable Hardware, 2002. Proceedings. NASA/DoD Conference on*. IEEE, 2002, pp. 167–176.
- [20] P. Cariani, "To evolve an ear. epistemological implications of gordon pask's electrochemical devices," *Systems research*, vol. 10, no. 3, pp. 19–33, 1993.
- [21] A. Thompson, "An evolved circuit, intrinsic in silicon, entwined with physics," in *International Conference on Evolvable Systems*. Springer, 1996, pp. 390–405.
- [22] S. Harding and J. F. Miller, "Evolution in materio: A tone discriminator in liquid crystal," in *Evolutionary Computation, 2004. CEC2004. Congress on*, vol. 2. IEEE, 2004, pp. 1800–1807.
- [23] S. Nichele, O. R. Lykkebø, and G. Tufte, "An investigation of underlying physical properties exploited by evolution in nanotubes materials," in *Computational Intelligence, 2015 IEEE Symposium Series on*. IEEE, 2015, pp. 1220–1228.
- [24] P. Aaser, M. Knudsen, O. H. Ramstad, R. van de Wijdeven, S. Nichele, I. Sandvig, G. Tufte, U. Bauer, Ø. Halaas, S. Hendseth, A. Sandvig, and V. Valderhaug, "Towards making a cyborg: A closed-loop reservoir-neuro system," in *14th European Conference on Artificial Life*, vol. 14. MIT Press, 2017, pp. 430–437.
- [25] S. Harding, J. Koutnik, K. Greff, J. Schmidhuber, and A. Adamatzky, "Discovering boolean gates in slime mould," *arXiv preprint arXiv:1607.02168*, 2016.
- [26] S. Nichele, S. Farstad, and G. Tufte, "Universality of evolved cellular automata in-materio," *International Journal of Unconventional Computing*, vol. 13, no. 1, pp. 1–34, 2017.
- [27] H. Broersma, F. Gomez, J. Miller, M. Petty, and G. Tufte, "Nascence project: Nanoscale engineering for novel computation using evolution," *International journal of unconventional computing*, vol. 8, no. 4, pp. 313–317, 2012.
- [28] O. R. Lykkebø, S. Harding, G. Tufte, and J. F. Miller, "Mecobo: A hardware and software platform for in materio evolution," in *International Conference on Unconventional Computation and Natural Computation*. Springer, 2014, pp. 267–279.
- [29] H. Hamann, M. Wahby, T. Schmickl, P. Zahadat, D. Hofstadler, K. Stoy, S. Risi, A. Faina, F. Veenstra, S. Kernbach *et al.*, "Flora robotica-mixed societies of symbiotic robot-plant bio-hybrids," in *Computational Intelligence, 2015 IEEE Symposium Series on*. IEEE, 2015, pp. 1102–1109.
- [30] F. Veenstra, A. Faina, K. Stoy, and S. Risi, "Generating artificial plant morphologies for function and aesthetics through evolving l-systems," in *Proceedings of the Artificial Life Conference*, 2016, pp. 692–699.
- [31] V. Manzella, C. Gaz, A. Vitaletti, E. Masi, L. Santopolo, S. Mancuso, D. Salazar, and J. de las Heras, "Plants as sensing devices: the pleased experience," in *Proceedings of the 11th ACM Conference on Embedded Networked Sensor Systems*. ACM, 2013, p. 76.
- [32] K. Aditya, Y. Chen, E.-H. Kim, G. Udupa, and Y. Lee, "Development of bio-machine based on the plant response to external stimuli," in *Robotics and Biomimetics (ROBIO), 2011 IEEE International Conference on*. IEEE, 2011, pp. 1218–1223.
- [33] M. Mohid, J. F. Miller, S. L. Harding, G. Tufte, O. R. Lykkebø, M. K. Massey, and M. C. Petty, "Evolution-in-materio: A frequency classifier using materials," in *Evolvable Systems (ICES), 2014 IEEE International Conference on*. IEEE, 2014, pp. 46–53.
- [34] M. Gagliano, S. Mancuso, and D. Robert, "Towards understanding plant bioacoustics," *Trends in plant science*, vol. 17, no. 6, pp. 323–325, 2012.
- [35] M. Gagliano, M. Renton, N. Duvdevani, M. Timmins, and S. Mancuso, "Acoustic and magnetic communication in plants: is it possible?" *Plant signaling & behavior*, vol. 7, no. 10, pp. 1346–1348, 2012.
- [36] <http://www.alparadisodifrassina.it/en/il-flauto magico>, "Al paradiso di frassina, special selection flauto magico," 2016, accessed: 2016-12-20.
- [37] T. Turlings, J. H. Loughrin, P. J. McCall, U. Röse, W. J. Lewis, and J. H. Tumlinson, "How caterpillar-damaged plants protect themselves by attracting parasitic wasps," *Proceedings of the National Academy of Sciences*, vol. 92, no. 10, pp. 4169–4174, 1995.
- [38] L. Beloff and J. Jørgensen, "The condition: Towards hybrid agency," in *International Symposium of Electronic Arts*, 2016, pp. 14–19.