

How can social interaction and relaxation be achieved through publicly installed sound producing objects.

Kwame Adu-Mensah

Masters project in Partial fulfilment for the Degree of Master of Product Design Oslo And Akershus university of Applied Sciences Norway
May, 2012

Contents

AKNOLWLEGEMENTS.	5	
1.0 INTRODUCTION	6	
1.1 Background To The Study	6	
1.3 Research Question	7	
1.4 Research objectives	7	
1.5 Scope	7	
2.0 RESEARCH METHODS.	8	
3.0 BACKGROUND RESEARCH THEORY	9	
3.1.0 Social Interaction	10	
3.1.1 Norwegian experience	12	
3.1.2 Interview	13	
3.1.3 Negative effects of technology	14	
3.2.0 PRODUCT INTERACTION.	16	
3.3.0 SOUND	21	
3.3.1 Sound Propagation	22	
3.3.2 USES OF SOUND/MUSIC	23	
3.3.3 Sound Direction	25	
3.4.0 RELAXATION	26	
3.4,1 Listening Style And Strategies	27	
3.4.2 Moods	28	
3.5.0 BACKGROUND RESEARCH VISUAL	30	
4.1.0 ANALYSIS/CONCLUSION	33	
4.1.1 Findings/Results	34	
4.1.2 Design brief	35	
5.1.0 Concept Map	36	
<i>Proposed concepts/ideas.</i>		37
<i>Proposed concepts/ideas.</i>		38
<i>Proposed concepts/ideas.</i>		39
<i>Proposed concepts/ideas.</i>		40
<i>Proposed concepts/ideas.</i>		41
<i>Proposed concepts/ideas.</i>		42
<i>Proposed concepts/ideas.</i>		43
<i>Final concept/idea.</i>		44
<i>Ideation.</i>	45	
<i>Sketch</i>	46	
<i>Movement</i>	47	
<i>Movement</i>	48	
<i>Rendered model of wheels</i>		53
<i>Rendered seat</i>	54	

AKNOLWLEGEMENTS.

Acknowledgements

I hereby acknowledge the following for their contribution to this project:

Halvor Skrede(Supervisor)

PhD Student, Faculty of Product Design, Oslo and Akershus University College of Applied Sciences., Norway

.

Tore Gulden

Professor, Faculty of Product Design, Oslo and Akershus University College of Applied Sciences., Norway

.

Staff of the Faculty of Product Design, Oslo and Akershus University College of Applied Sciences., Norway

Rolf Inge Godoy

Professor,University Of Oslo Faculty of Humanities

Kenneth Sørheim C.E.O Kamfer, Norway

1.0 INTRODUCTION

This section gives a brief background about the research, the research question and the some insight into the research methods used .

1.1 Background To The Study

Human interaction is one of the most intimate and important aspects of being human and it is very vital on a daily basis. To enhance this interaction will bring about new and indispensable ways of understanding or effectively improving the lives of people. Human interaction also helps to break barriers and to bring harmony in the society that we live in thereby providing tolerance for one another. As a result of the changing dynamics of humans and social setups in what ways can human interaction be improve or made more creative. Can new and innovative means be used to connect and bring people together in better ways? Most often advances in technology we know today has more or less improved our lives but in some ways too affected our socializing skills or inter-human interaction skills. In some way one can say that a means of creating some form of interaction between people is to introduce a third party object or service of design form. Through the interaction with the said object , product or service there can be some form of interaction.

1.3 Research Question

The following research question was the focus of this research

How can social interaction and relaxation be achieved through publicly installed sound producing objects.

1.4 Research objectives

This thesis is a follow up to previous research on music and seating done in a previous project by the student(refer to attachment). The main objective was to find out new ways of enhancing social interaction through concept development, and to come up with a device , product or service that can enhance this.

1.5 Scope

The project was mainly geared towards urban settings and urban environments as well a recreational areas like parks and in public spaces such as city squares and open spaces in the city.

2.0 RESEARCH METHODS.

Face to Face interviews.

Interviews were conducted with some professionals in the various fields of interest to the project namely sound and music research and social anthropology. There were other interviews and minor discussions about the various aspects of the project with individuals and class discussions for idea generation and feedback.

The face-to-face method is widely used in research and involves the direct meeting of the interviewer and the interviewee. This method has the advantage of being able to obtain more information due to personal communication and direct interactions. It ensures full and accurate data.

Designer in fieldwork.

Research was also undertaken into other aspects of the project and this required some ground work and observation in the field of design and public installations.

With this method the researcher obtains better knowledge of his research through fieldwork by gathering data about the social world by observations, interactions with people and observing them in their natural setting. (Meyers, 2008)

3.0 BACKGROUND RESEARCH THEORY

This part of the report aims to provide a background of theory for further research and to formulate the design criteria and proposals and concepts. The following areas of research were observed and explored.

- Social interaction and product interaction
- Research into music and sound production
- Research into moods and relaxation
- Research into sound and seating.

There was also visual research into the following

- Open interaction between people in public places
- Interaction experiments
- Interviews and discussions
- Questions

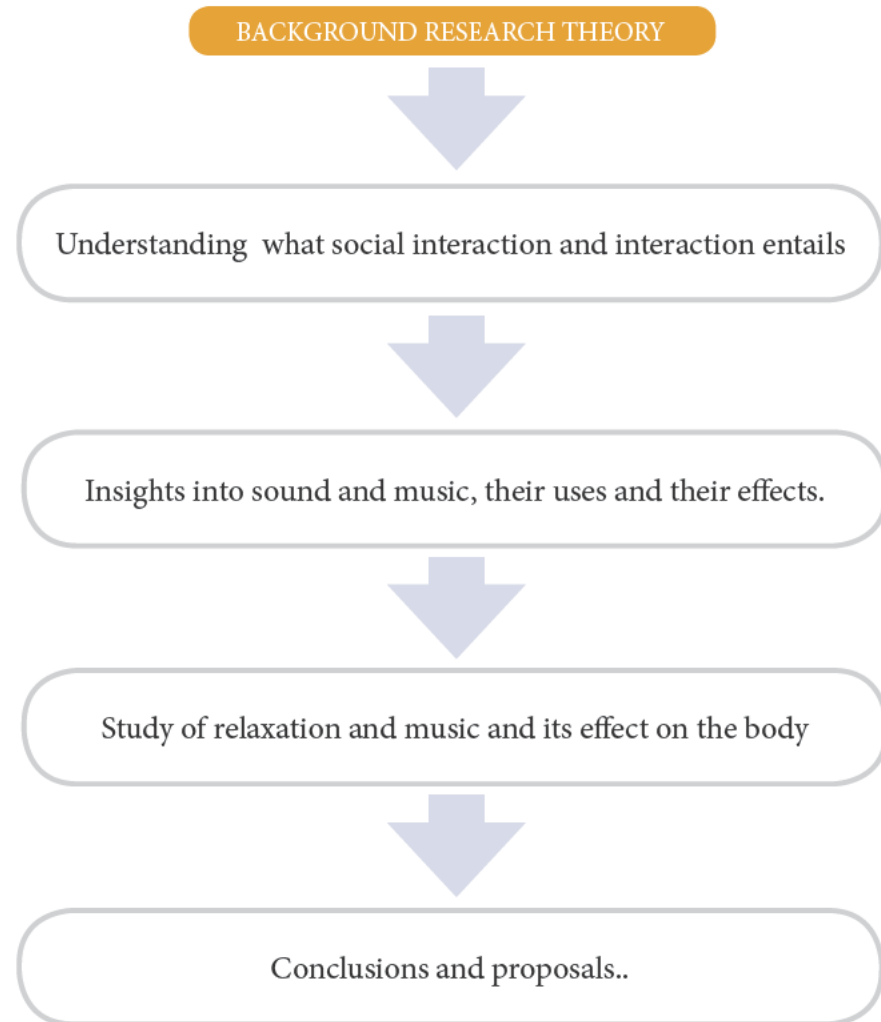

3.1.0 Social Interaction

Interaction is a mutual or reciprocal action or influence. Other definitions for interaction are a kind of action that occurs as two or more objects have an effect upon one another. The idea of a two-way effect is essential in the concept of interaction, as opposed to a one-way causal effect. (The Merriam-Webster dictionary)

So for socialising to occur there has to be a reciprocation of effect on the people involved. This can occur through physical and emotional means. For example shaking of hands and responding to a greeting.

Gary Rodgers also talks about social interaction and defines it as “the process in which people act towards or responds to others.” He further goes on to talk about “nonverbal communications that occur during social interactions such as facial expressions which is a rich source of nonverbal information because they reveal emotions so directly”.

Interaction therefore can be said to be the ability of two or parties for contact and exchange of verbal and non verbal cues through communication. This results in an exchange of information .



Image 1



Image 2

Socialising or mixing with people is very important part of our everyday lives.

Human interaction occurs in all aspects of our lives such as meeting people everyday , in work in school in the shop etc. Socialising and human interaction in some cases occur without a second thought whiles in other cases it requires some sort of catalyst to start.

A lot of factors influence how people socialise. Factors like language and culture, location, interests and ideologies as well as relation and sports or recreation. New and ever more increasing ways are being sought to enhance the ways in which people relate and interact with each other.

To begin with i want to focus on the what interaction is and the narrow down onto the type and in particular the two forms of interaction which support my research most.



Image 3



Image 4

Background research.

3.1.1 Norwegian experience

Norwegians or most people in Norway are considered reserved and inward, and tend to keep to themselves. You may also find that Norwegians are not outwardly social, and are unlikely to greet you in shops or in the street or even in social settings until they know you. Norwegians put a high priority on spending time with their families, and are likely to go home straight after work.

Due to this there tends to be quite minimal contact with other people or socializing doesn't occur frequently outside of inner circles or close groups.

For instance in the public places there tends to be some form of holding back or restraint in getting or interaction with each other.

Others wrestle with what they feel is an appropriate form of behaviour towards someone else especially a foreigner and as such in order to avoid offending them and therefor they might seem to keep to themselves.



Image 5



Image 6



Image 7

Background research.

3.1.2 Interview

In order to get a better understanding of Norwegian culture and the Norwegian society I met and had a discussion with Kenneth Sørheim a social anthropologist the CEO of Kamfer, a caring company which started operations in 2005.

Based on the interview it came to light that the isolation of or the perceived isolation of Norwegians and their introvert nature is due to some factor which occurred in the past. In the past the typical Norwegian societies lived in the farms quite a distance apart from each other and as such most family never really interacted or mixed much with neighbouring farmers unless for the occasional meeting .

Kennth gives an analogy of how at his University they had a task for his introductory anthropology class. They were put into groups where they were each group was supposed to come or act out a typical Norwegian behaviour. According to him there was no interaction between the groups so none of the groups knew what the other group was coming out with.

Three out of the six groups came out with the same situational phenomenon that manifests a typical Norwegian behaviour. Kenneth's group was one of the three and the situation they came up with was the concept of what happens in the tram. They asked what the typical Norwegian behaviour in Oslo is and what sort of

revels and manifests a typical Norwegian behaviour?

On a typical Friday night on the tube or tram between the hours of five o'clock to eight o'clock most Norwegians are going home after the day's work it is typical to find people either reading, listening to music,

or just sitting quietly in silence rarely talking. looking out the window, talking on the phone or fiddling with the phone, I don't mind you don't mind me we are happy very introvert and cold in a way.

But all that changes when it gets to about 11 pm when people having going out for the night to party then you will see the difference in the average Norwegians attitude and it's because they are drunk. After a few bottles the Norwegian transform into an extrovert outgoing person who wants to talk and interact with you. The person just has to lighten up with a few bottles and doesn't even have to be drunk. So then the question was is it a bad thing or a good thing or just a cultural thing.

Its quite hard to explain why Norwegians seem to be afraid or closed up, but thankfully urbanization and introduction of foreign cultures into the Norwegian society is helping to open up the Norwegian attitude and society. To round up I asked if he felt that music or sound can cause people to interact and can music help in encouraging interaction. And his opinion was that music is universal and does help and bring people together.

3.1.3 Negative effects of technology

Other reasons can also be attributed to the use of technology has for or gradually reduced our physical social interaction skills and inter personal relation skills. It has more or less become a quick fix or quick means to prevent having to physically be there or break the ice on meeting someone. For example social interaction sites like Facebook and Twitter which are supposed to bridged the gap and encouraging socializing a lot have in my view also created other problems like building up the shyness of people, who rather than going out and having the human connection with others would rather have it on the internet .The interaction cues we get from actually being present with someone or having a sense of their presence watching their reactions and facial cues live, smelling them feeling or even touching them is sort of missing.

So is technology really agradually making people isolate themselves more? Just as Kenneth mentioned in his interview about typical Norwegian behaviour, if we take the typical bus or train ride home in a typical Norwegian day of work, it is so obvious to notice how people tend to look for the first empty seat as to sit on as against sitting next to another passenger. There seems to be some sort of fear of having to interact with the person, and to prevent that the typical passenger would prefer to sit alone.



Image 8

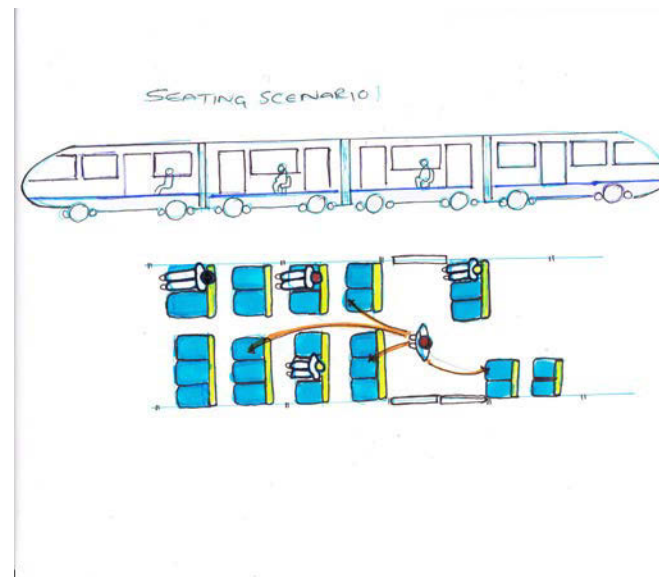

Image 9

After sitting down they would plug themselves into their personal music device or Mobile device and close up finding some solace or closure in their device, away from the rest of the world and its troubles.

Having had a rough day, a long journey or just not wanting to be bothered might be some of the reasons. But inherently this effect of isolation is becoming more and more accepted or encouraged.

Research has shown that there is a gradual decline in the interaction or socializing of people families and society in general. Putnam talks about social capital theory and the value of social networks in his book and how just as screw driver(physical capital) or a college education (human capital) can increase productivity(both individual and collective), so too social contacts affect the productivity of individuals and groups. He further states that “social capital refers to connections among individuals –social networks and the norms of reciprocity and trust worthiness that arise from them. (Putnam, 2001)

In that sense social capital is closely related to what some have called civic virtue”. But he explains that “a society of many virtuous but isolated individuals is not necessarily rich in social capital”.



Image 10

So we can see that this gradual culture of isolation does have negative on productivity. And in terms of reaching out and creating a truly free and open society that should be interactions to break down prejudices phobias and paranoias of other people and other cultures.

3.2.0 PRODUCT INTERACTION.

What makes people touch something for the first time? And after such an interaction with the object what is the response to the object? What makes a person go past the barrier that stops them from touching or interacting with something? How does the interaction occur? Is it active or passive? Is it by invitation or does it occur by virtue of being present at the place at the time?

What is interaction at all?

In an article titled what is interaction? Are there different types? by Hugh Dubberly and Usman Haque, they cite Meredith Davis who argues that

Interaction is not the special province of computers alone, and goes on further to point out that printed books invite interaction and that designers consider how readers will interact with books. She cites Massimo Vignelli's work on the National Audubon Society Field Guide to North American Birds as an example of particularly thoughtful design for interaction. (Dubberly, Haque, & Pangaro, 2012)

So interaction in its simplest form can be said to be anything that can be felt or touched or invites one to explore and connect with it.

Interaction with an object can be passive or active depending on



Image 11



Image 14



Image 13



Image 12

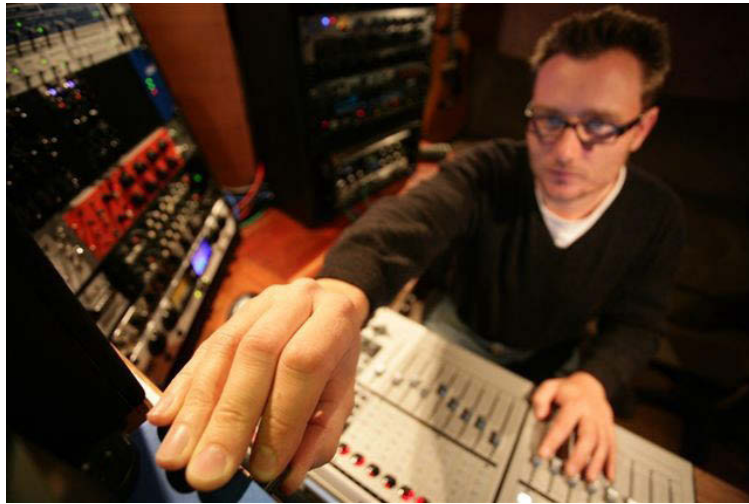

Image 15



Image 16

the individual and how they relate or what they seek to achieve from relating with the object. Active interaction occurs when a person sees an object or product and engages, explore and use the object or product, whereas passive interactions is when the person just notices or observes the object or product without use or engagement. But in both cases it can be said that interest is also a factor.

In his chapter titled *Philosophy of Interaction and the Interactive user experience*, Svanaes states

The Merriam-Webster dictionary defines interaction as “mutual or reciprocal action or influence”. Taking this definition as a starting point, what does it mean for something to be interactive? A product or service is interactive if it allows for interaction. An artefact’s interactivity is its interactive behaviour as experienced by a human user. Or to be more precise, it is the potential for such experiences. Its interactivity is a property of that artefact; alongside other properties like its visual appearance. Interactivity can also be used as a noun to signify everything interactive, similar to how radioactivity refers to everything radioactive. (Svanaes 2011)

Many definitions exist for “the user experience”. I prefer this one: “a person’s perceptions and responses that result from the use or anticipated use of a product, system or service” (ISO 2009) (Svanaes, 2011).

Richard Buchanan goes on to talk about interaction as “a way of framing the relationship between people and objects designed for them—and thus a way of framing the activity of design”. He further states that “man-made ob-

jects offer the possibility for interaction, and all design activities can be viewed as design for interaction. The same is true not only of objects but also of spaces, messages, and systems. Interaction is a key aspect of function, and function is a key aspect of design”.

So in retrospect, the potential for an object or product or a service to be interactive is based on the character of the object in that all objects and services provide the opportunity for interaction. what then are the kinds of interaction if there are any and how are they categorised? To enable it to be used for product development.

To us interaction occurs on a daily basis through our daily activities and most time we seem to take them for granted the number of times we interact with other, objects services etc.

Svanaes gives an example of one of the simplest form of interactive products being a touch-sensitive light switch on a lamp, which when touched turns on the lamp and turns it off again when touched again. This can be considered as quite a simple form of interaction as opposed to the complex button and displays found in the control room of a music recording studio or say a modern war ship.(Svanaes,2011)

Yet, with all these screens and complex display if there are no buttons or switches which allow for adjustments and tweaking or some form of feedback, on its own doesn't allow interaction to occur. So we can say that for an object, device, product or service

to be considered interactive, weather very intricate and complex or very simple, it should be made in such a way as to give feedback or respond to user actions.

It is through these responses or feedback that the user can receive the cues or possibly the desired results from the use of the product or object. This is very vital in the design process since it has a great influence on the overall design and function, as well as the target group or market for the product. It is also a key part of the design process since it can be used to influence behaviour change in people. Provided the product is easy to use, effective and gives a good user experience. The manner in which one interacts with a product become registered in an individual after a while and forms a habit. The advantage of having a habit is that you do not have to think or consider different alternatives each time you act, and this becomes apparent in the use of the product after a period of time .



Image 17

3.2.1 Affordance

Affordance can be said to be the properties of an object or product that allows its function or usability to be known due to its form or physical properties. The term was originally coined up by James J. Gibson in his book titled *The Ecological Approach to visual Perception*.

Sogarrd explains affordance in his article into detail and talks about how the term was originally coined by James J. Gibson but was later re introduced in a different way by Donald Norman.

Gibson's concept of Affordance was mainly concerned with the ability to perceive an object's usability irrespective of the physical or environmental properties that show how the object functions or is to be used. For example a door's affordance of being able to be opened and closed, relative to the user. But the door being camouflaged or hidden and the door's features or physical attribute like a handle or not being visible to the user to enforce the Affordance of its usability.

He further explains though that when the object's (in this case a door) usability can be perceived in connection with its physical attribute that show how it can be used (visible door handle) a state of direct perception is attained.

Norman however in his book states :

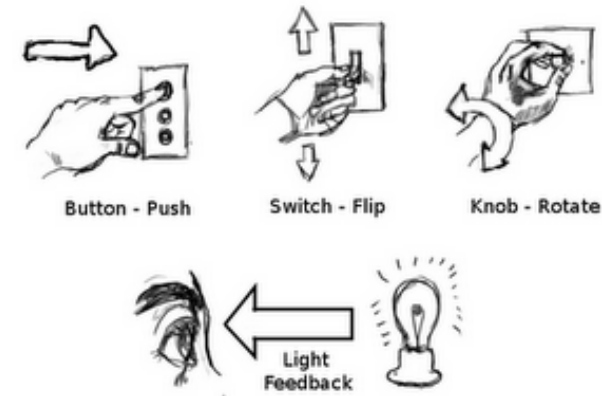

Image 18

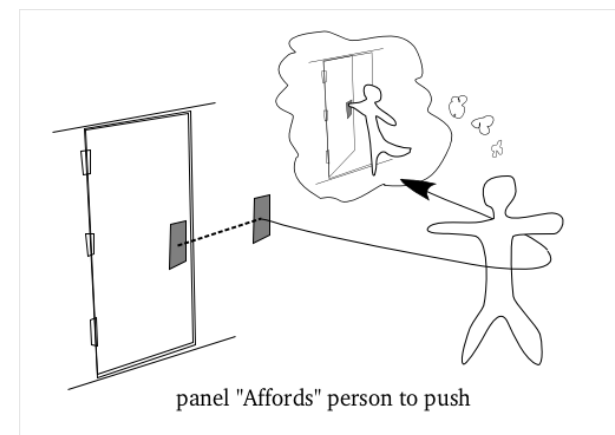

Image 19

“...The term Affordance refers to the perceived and actual properties of the thing, primarily those fundamental properties that determine just how the thing could possibly be used. [...] Affordances provide strong clues to the operations of things. Plates are for pushing. Knobs are for turning. Slots are for inserting things into. Balls are for throwing or bouncing. When Affordances are taken advantage of, the user knows what to do just by looking: no picture, label, or instruction needed.” (Norman 1988, p.9)

In effect both of their arguments are based practically on trying to find a proper definition for the term Affordance, but Norman later on went on to correct his definition by calling it perceived Affordance. In relation to the design of object and products though Affordance is a key factor that should be considered as it's through it that we can have interaction with object or product that are designed and produced for use. For instance perceived Affordance can trigger an interest in an object or product leading to direct active interaction with the object (Image 21). It can also allow or give the individual an idea of how the product functions in the initial stage and spark up interest in the object or product, and its use. Through Affordance we can design products that are not only useful but also allow for interaction through information that show its Affordance for use.



Image 20



Image 21

3.3.0 SOUND

What is sound? What is music? How are the two related? How do they function in our daily lives and experiences? Do they enable us to relax and do they affect our moods? Sound or music can be found all around us. From the basics of speaking to someone, the blaring sounds of speakers at a rock concert. Music or sound can be classified according to the environment or purpose of its use. From warning signals to the sound feedback from using our mobile phone, ATM's, to car horns and music from our personal music devices.

sound is the vibrations that travel through the air or another medium and can be heard when they reach a person's or animal's ear". Other definitions include (also musical sound) sound produced by continuous and regular vibrations, as opposed to noise. (The oxford dictionary)

Scientifically speaking a sound is literally just a pressure wave travelling through a medium, such as air or water. Sound has absolutely no volume or frequency unless there is a receiver nearby to pick it up, such as the human ear or a microphone. So, if a tree falls in the forest and no one is around to hear it, does it make a sound? In the sense of being perceived as a sound, the answer is no. However, if sound is defined as a series of pressure waves (prior to being received), the answer is undeniably yes.(Hermann, Hunt, & (Eds.), 2011).

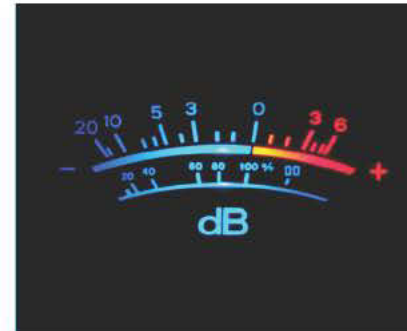

Image 22



Image 23

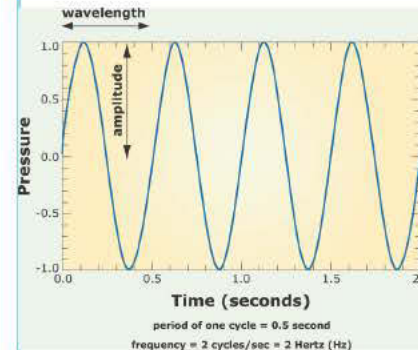

Image 24



Image 25

3.3.1 Sound Propagation

Sound propagation occurs through media such as air or water as well as solids. The medium affects the waves of the sound in many ways and can cause the waves to be refracted, reflected or attenuated. The behaviour of a sound or sound wave can be affected by factors like the temperature, pressure, viscosity. Density of the atmosphere for example tends to determine the speed at which the sound travels. Other factors like the movement of the medium can cause the sound to travel further both dependent and independent of the position of the media. Wind carries sound produced by a stationary object for example away from it.

Sound reflection occurs when a sound wave bounces off an object or a surface. However the structure and nature of the surface can cause variations in the reflected sound. For example a smooth porous surface might absorb the sound and reflect it poorly and a rough irregular surface may deflect and scatter the sound.

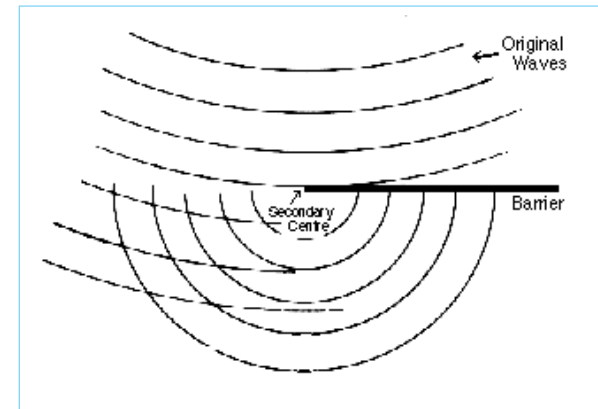

Image 26

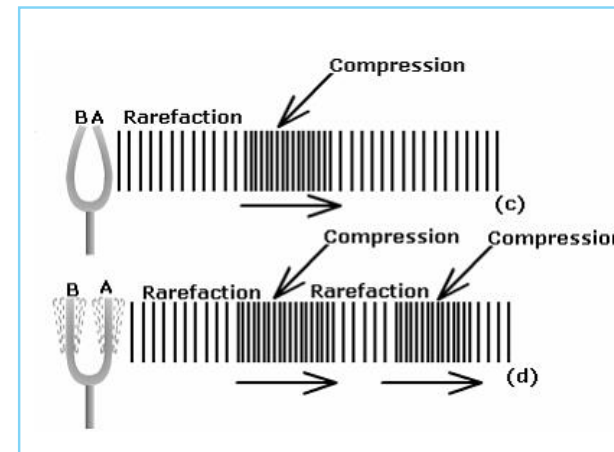

Image 26

3.3.2 USES OF SOUND/MUSIC

Martin Clayton gives some insight into the functions of music. He talks about some of the functions of music in his chapter. He states that

Music is not a single form of behaviour any more that it is a single kind of sonic product but a composite of different forms of sound and behaviour.

He gives some insight about the functions of music such as the regulation of the individuals cognitive or psychological state, for example when listening to music be it live or stage performance , or a recording as a tool for example in altering moods, i.e. Self-regulation.

Mediation between self and other and explains how music has been used as a tool for interacting in situations where talking or speaking or communication is insufficient . Music then becomes a very flexible tool for deliberation relations between one's self and others.

Coordination of action

Humans have the ability or the urge to adapt their physical actions to one another or to and eternal source of sound such a sound performance or a recording.



Image 28



Image 30



Image 29

There are many ways in which sound can be used to interact or cause interaction to occur between people, products or object every day. One examples is the Piano stairs which was installed in Odenplan Stockholm, the stairs of an underground metro. The concept of it was to encourage people to take the stairs rather than the escalator. Doing so was much more healthy as it encouraged exercise. Basically to change the behaviour of people in a fun way through their interaction with the set up. The set up worked very well and it was fun and got the better part of peoples curiosity. One can however argue that people can also get tired of the same experience and if they lose interest in it they will revert to using the escalators again. Others might even find the sound annoying after a while, and consider it a nuisance. Then there is also the problem of urban youth and vandals who might destroy or use it to irritate others. There have been other similar project in the past like the Interactive Chronology Company, which had a similar set up but rather than a piano the stairs gave information about media artworks and exhibitions in 1991. This information was given out by as steps were taken on the stairs.



Image 30



Image 31



Image 32

3.3.3 Sound Direction

Sound direction is also of importance in the propagation of music. Subtle sounds directed in the right manner, can enhance the mood of a person or irritate them. But this usually depends in most cases on the level of sound and the type of sound that is being propagated.

Woody Norris, an inventor based in the United states has been working on the process of directing sound using ultrasonic waves, and has patented a device that allows sound to be direct to specific targets without disturbing other targets in the process. Therefore those in the line of the sound are the ones who hear it. (Norris, 2011)

This devise can be integrated to produce a product that can be used for instance in the home for personal listening of music, without the hassle and negative effects of loud sound from ear-phones as well as the discomfort of having such ear devices in the ear.

When this technology is coupled with seating it can bring about endless possibilities and new concepts of interaction with sound production for relaxation. For public seating installations it becomes useful in the scenario where there might be a public place of interest, a sculptural piece or a distinct feature in the surrounding, and such a seating could be used to give information to the user of the seat about such paces by the integration with the seat,

while not disturbing other users of the seating fixture.



Image 33

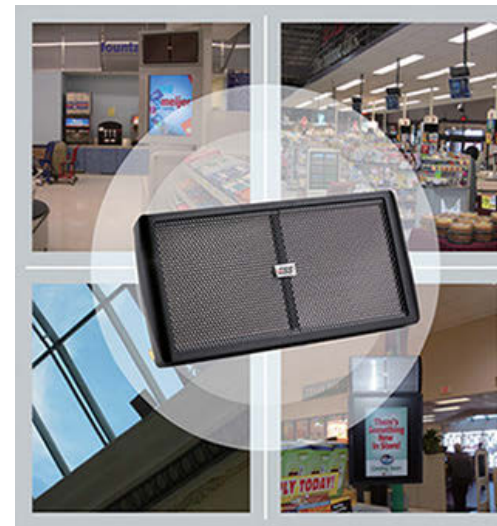

Image 34

3.4.0 RELAXATION

When we talk of relaxation, all sorts of images come to mind. For some people relaxation can take many forms. For someone it may be lying on a sunny beach in the Bahamas, taking a long holiday away from the stress of office work. strolling in the woods in the evenings

Someone else might find relaxation in smoking a fine cigar while sipping on some whiskey in his private den. For someone else it a nice leisurely Stroll in the park or the forest. There are a lot of views and opinions on what exactly relaxation is and a varied landscape of answers as well as countless books and videos on how to achieve the best forms of relaxation. Many techniques and suggestions, aids like scented candles, aromatherapy massage, and all the stereotype ideas of how relation is viewed. But one thing that is prominent in this is the effect of an individuals mood on his state of being relaxed.

Relaxation is of prime importance to every human being .Due to the stressful nature of urban living in the modern world, excesses of stress leads to sickness like heart disease, high cholesterol and mental imbalances and generally unhappy lifestyles. Living in urban areas also has a lot of stress on individuals and their daily schedules and repetitive job tasks as well as lifestyles takes a ma-

ajor toll on the individuals. A lot of research and studies exist on the effects of stress on the human body and a lot of proposed solutions to deal with stress related issues..

Relaxation therefore is key in the development of a healthy sound mind and body and it is with this notion that we have parks and recreational facilities built into our urban surroundings as well as other places of interest to afford for relaxation of the mind and the body. Typical example of places that afford relaxation are parks and recreational grounds, walks in the woods, art galleries and exhibitions, or generally to sitting in public squares drinking some coffee at coffee bar just to name a few.



Research has shown that music has an effect on mood. In his research into music's relationship to the body and music listening Høyvik observes:

The men and women in both groups claim they are able to feel the music they listen to “in their bodies”. Sometimes when they listen to music they describe seeing “things”—landscapes, other people, themselves as others, or even that while listening to music they feel as if they are “seen” by others. Sometimes they tell me that such experiences with music also make them feel better. I argue that these claims should be viewed as relevant information to modern medical discourse and institutions.(Høyvik, 2007)

3.4,1 Listening Style And Strategies

.In a presentation at the Society for Music Theory 2002 Conference, (Huron, 2002)proposed 21 listening styles. In the presentation he talks about Programmatic, and kinesthetic listening.

Programmatic listening

While listening to music, many listeners imagine certain situations or visualize certain scenes such as rolling waves, mountain vistas, city streets, and so forth. In programmatic listening the listening experience is dominated by such forms of nonmusical preferentiality. Musical works that are overtly programmatic in construction may be assumed to enhance or promote such a listening mode. However, programmatic listening may arise even in the case of ostensibly non-participant works.

Kinesthetic listening

This form of listening is characterized by the auditor's compulsion to move. Feet may tap, hands may conduct, or the listener may feel the urge to dance. The experience is not so much one of 'listening' to the music, as the music 'permeating' the body. Kinesthetic listening is best described as 'motivation' rather than 'contemplation'.

Emotional listening

Emotional listening is characterized by deeply felt emotion. The music engenders feels of sorrow or joy, resignation, great satisfaction. Occasionally there will be overt signs of emotion, such as the sensation of a lump in one's throat, imminent or overt weeping, or smiling. The emotions may be related to current events in the listener's life, but the feelings are more apt to seem nonspecific and to arise 'from nowhere'.

Metaphysical listening.

Metaphysical listening is also similar to distracted listening insofar as the listener may not be especially attentive to the on-going perceptual experience. But the listener may be engaged in thinking about questions of some importance related to the work, such as: what motivated the composer to write this work? What does this music mean? Why do I find this work so appealing?

Distracted listening.

Distracted listening occurs where the listener pays no conscious attention whatsoever to the music. Typically, the listener is occupied with other tasks, and may even be unaware of the existence of the music.

3.4.2 Moods

Research also shows that music affects moods. While doing research on music listening as therapy and music's relationship to the body Høyvik, observes:

The men and women in both groups claim they are able to feel the music they listen to "in their bodies". Sometimes when they listen to music they describe seeing "things"—landscapes, other people, themselves as others, or even that while listening to music they feel as if they are "seen" by others. Sometimes they tell me that such experiences with music also make them feel better. I argue that these claims should be viewed as relevant information to modern medical discourse and institutions. Clearly there seems to be some sort of connection between music and how it affects the people who interact with it.(Høyvik, 2007)

It can be suggested that there are interactions in how we listen to music and how our bodies and moods react to music in the same way, subtle movements like bobbing of the head or tapping of the feet to music, all contribute to the way we interact with music.

Recently, there has been an explosion in products and services designed to develop the human brain through the use of music. Some researchers claim that certain types of music (particularly that of Wolfgang Amadeus Mozart) can improve a person's level of concentration, reasoning and even the ability of the human body to heal itself.

This phenomenon has been dubbed "The Mozart Effect." Many researchers believe that Mozart's music can "warm up" the brain by facilitating complex neurological activities that are necessary for high-level functions, such as those needed to solve complex math and science problems. (Ciares J & P, 2010)

There are so many examples to show how music or sounds can affect our moods and how they can affect moods. Night clubs and concerts are just a couple of places where people's moods to music can be seen to make them happy and joyful. Other places are how noise and unwanted sounds like horns from a traffic jam, or loud construction work. Sound therapy, where sounds and music are used to rehabilitate depression and stress and to calm people down.



Image 37



Image 37



Image 36

listening to the radio on the drive to work in the morning, a bad phone conversation, noisy neighbours are all examples of how moods sound and moods corelate. classical, Jazz or ock music can also affect the modds of indi- vidual based on their perefedrences for specific genres of music



Image 39

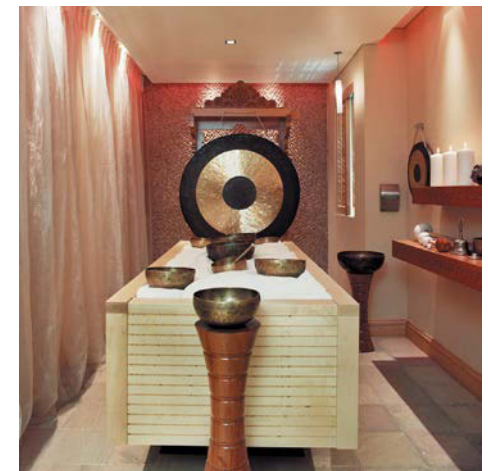

Image 40

3.5.0 BACKGROUND RESEARCH VISUAL

There was also visual research into the following

- Open interaction between people in public places
- Interaction experiments
- Interviews and discussions
- Questions

There are also references from the authors previous research into public installations and fixtures.

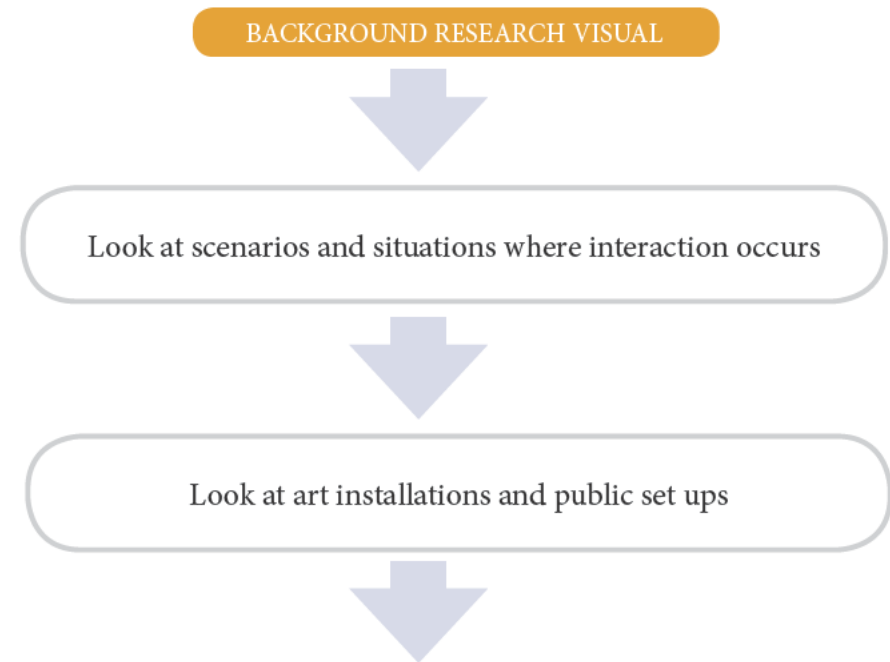

Look at scenarios and situations where interaction occurs



Image 40

Look at art installations and public set ups

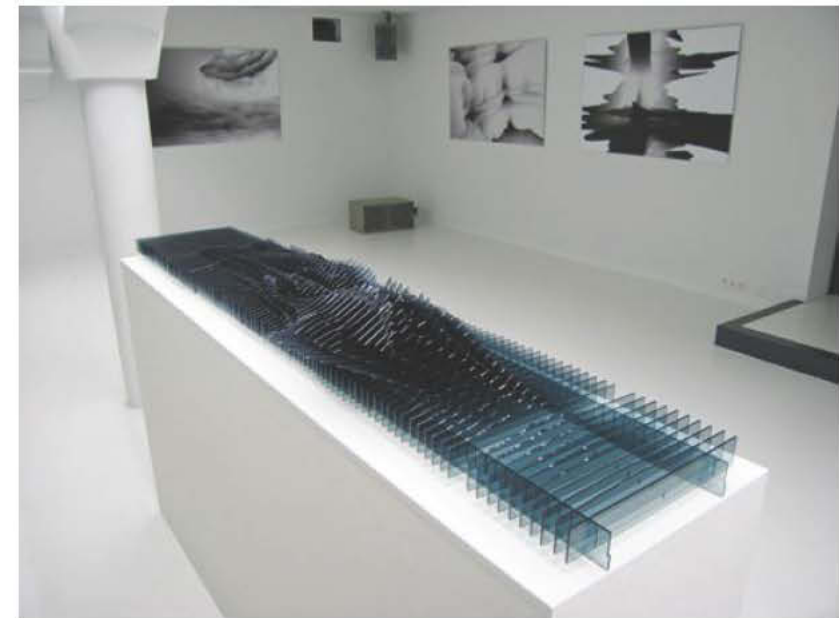

Image 41

4.1.0 ANALYSIS/CONCLUSION

One of the main findings was that Norwegians people are closed or reserved in and tend to keep to themselves. This is especially evident on the streets and in public transport like the trains and busses and the commonest thing most people do is prefer to sit on the nearest available seat which is empty rather than sit next to somebody.

Most people also like to spend time in public places and parks as well as recreational places.

Personal mobile devices and can also cause people to be withdrawn and isolated. It is very common to see people pull out their mobile device at the least instance when they are sitting on public transport or next to another passenger and preoccupy themselves with their devices. It is easy to argue that they have the right to do that or they are not obliged to have a conversation, but it seems that sort of behaviour is rather enforcing shyness and isolation and letting people lose their open social selves to be more closed up. It seems easier for and more comfortable for people to use social networking media to interact rather than one on one.

The one basic issue people face with interaction and communicating is how to break the ice or take the first step in connecting with the other person. Some manage to do so but stop short of a full conversation after a "hello" or a "hi how are you", after which there is usually no further communication. This occurrence has potential for the development of a product that can help in breaking the ice and drawing people together. In the process it encourages more interpersonal communication and openness.

Relaxation varies from person to person and what may seem relaxing for some people will be different for another person. But generally speaking most Norwegians enjoy outdoors and being in the sun especially during the summer months and so patronise parks and public places. This therefore gives the ideal environment to enhance social skills and openness of people and this can be achieved easily with public installations, that can be made to involve people to actively interact with.

Music is an excellent tool for drawing people together and also relaxing and mind. People socialise to bands and performances, and enjoy their own music forms. The differences in music tastes vary but it can be safe to assume that most people enjoy sounds and music they feel calm themselves and to generally make them feel good and brighten their mood.

4.1.1 Findings/Results

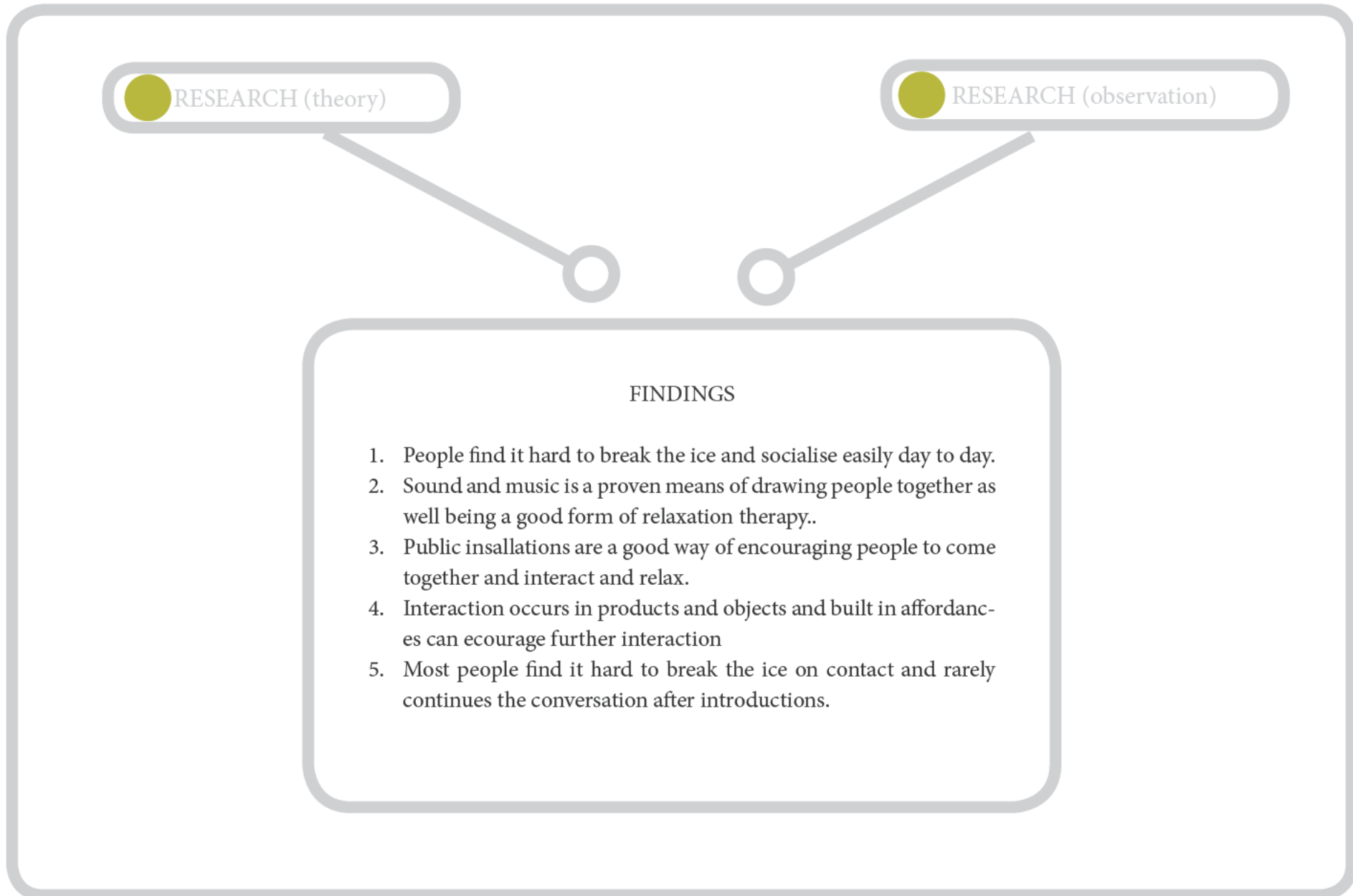

4.1.2 Design brief

Design Brief

Design brief of the situation and in relation to the objectives of the project the following is the basis for the design of and formation of the possible outcome of the problems at hand:

- Concept mapping
- Ideation sketches
- Concept sketches.
- Final concept.

The approach to the design of product is based on the factors that have been given. with emphasis on public seating and public installations , notably in parks and recreational areas..

- The design would have to be functional, drawing people together through music and seating. Also by the affordance of being a seat that provides rest.
- The set up of the seating which allows it to move and draw its user closer together for conversation. to foster interaction among them.
- Playing os sounds for relaxation.
- Where the product is the set up with the sound device and a set of moving chairs

Design requirements

- Sound Producing
- Should be relaxing
- Encourage socialising or trigger conversation.
- Publically installed.

5.1.0 Concept Map

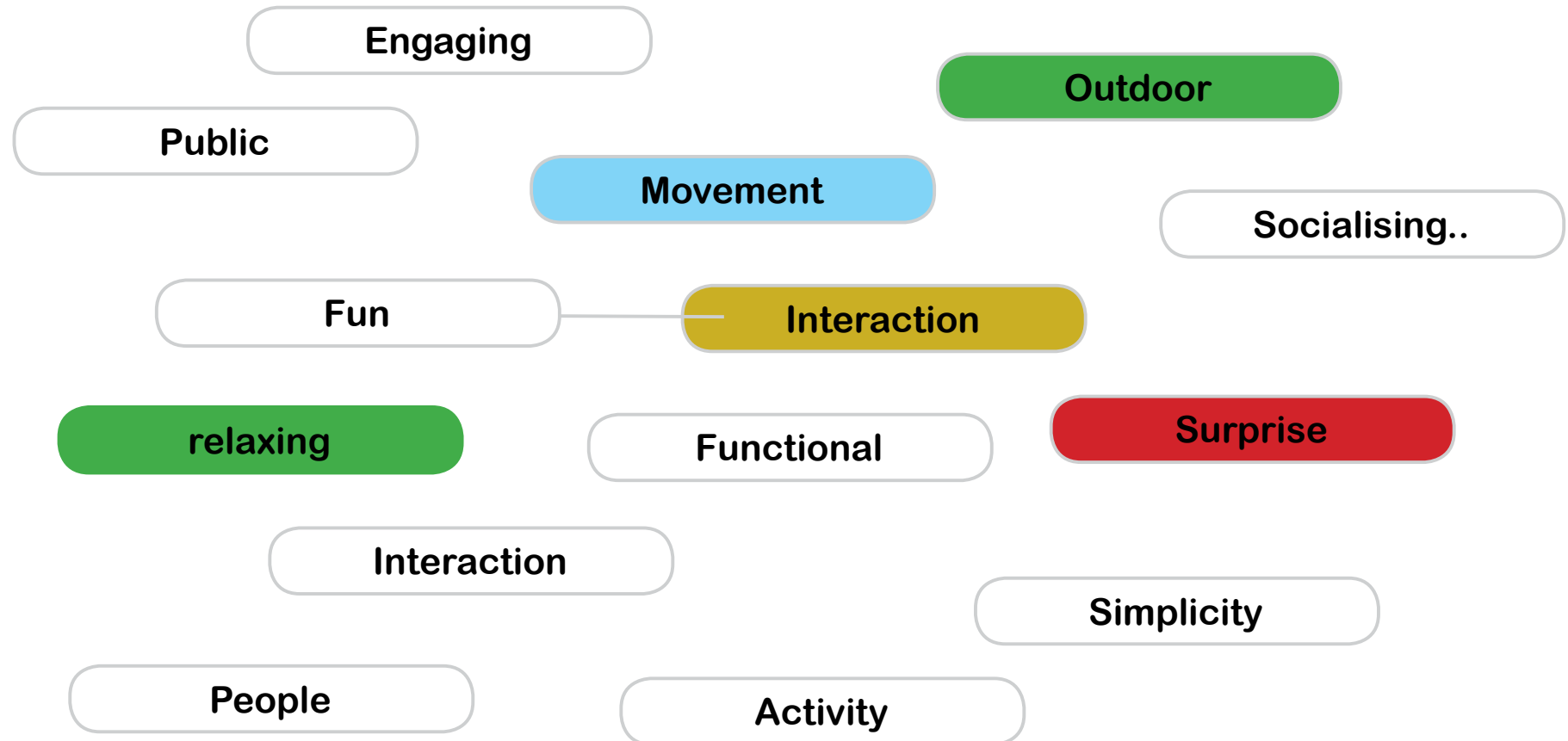

Proposed concepts/ideas.



- John meet James
- Hope You have a NICE CHAT.



This concept is bench that can encourage interaction and conversation when people use it. sensors detect when a person sits on it and a voice command welcomes and asks for the persons name. The voice then offers to some soft music or to give them information about where they are or the scenery .when another person comes to sit by the first person the voice will welcome and ask for the name of the new person and afterwards introduce then and asked for instance “I hope you have a nice conversation. Then to engage in conversation.

Proposed concepts/ideas.

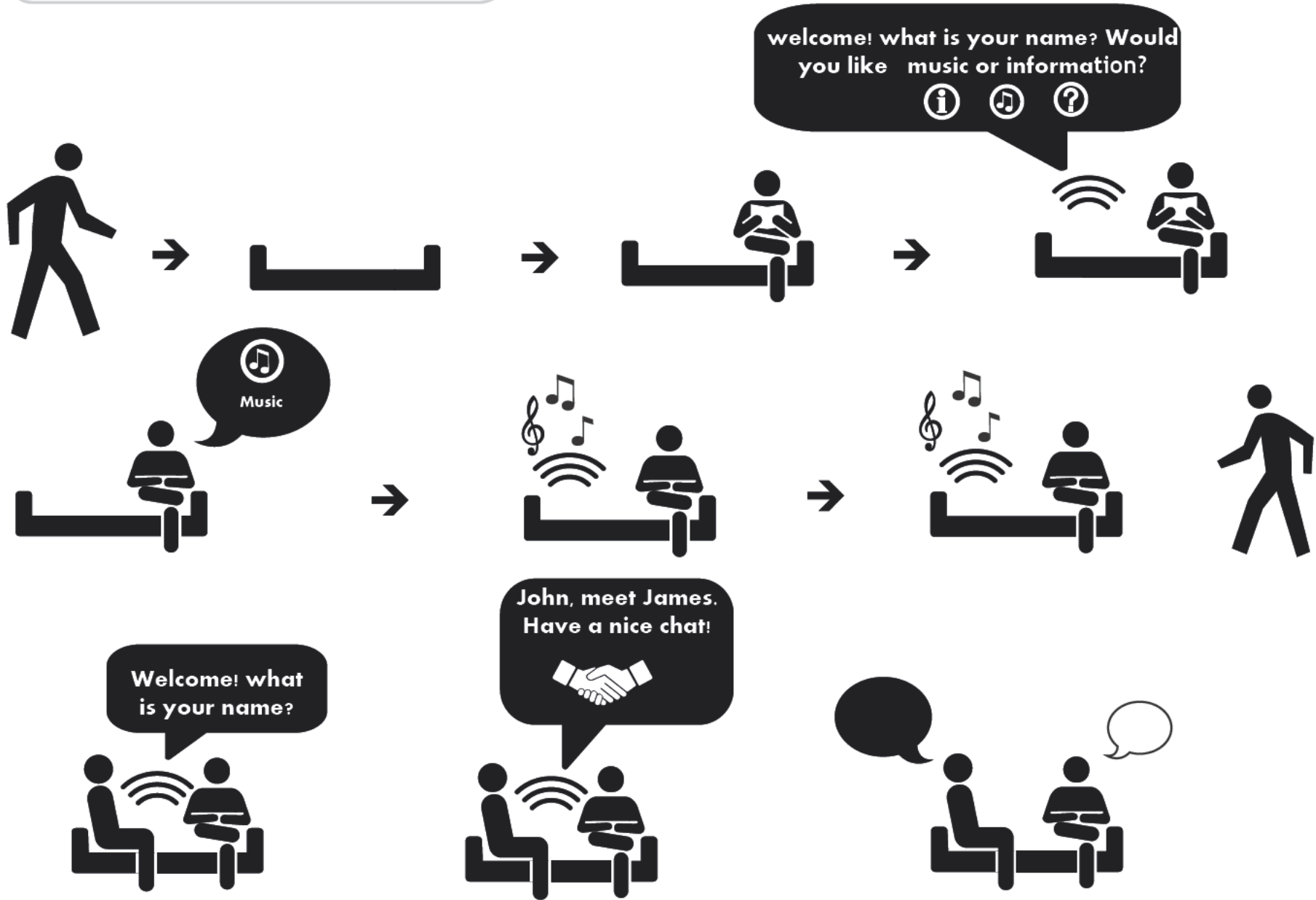

Proposed concepts/ideas.

This concept is taken from the concept of how kids used to play with cups and a string where the sound travels along the string so it can be heard by the other person along on the other side. The concept involves setting up of these devices next to public seating in the parks where one can communicate with a random person on another chair in the park. The set up would be made such that it allows one to see the other people in the park at a distance to get a sense of comfort at seeing the other person.



Proposed concepts/ideas.

Sound Massage

The second concept is based on music being used to relax the body. The concept works on the principle of vibration being used to relax and massage the body of the individual. The individual lies and or sits on the seating and the music being played soothes a the user at the same time massage the individual through the vibration from the amplified speaker system. The system can be controlled by the user and the choice of sound can be varied. From both the user and the device itself. The user can use their portable device to allow the music to be played. The system can be set up for urban environments and parks.

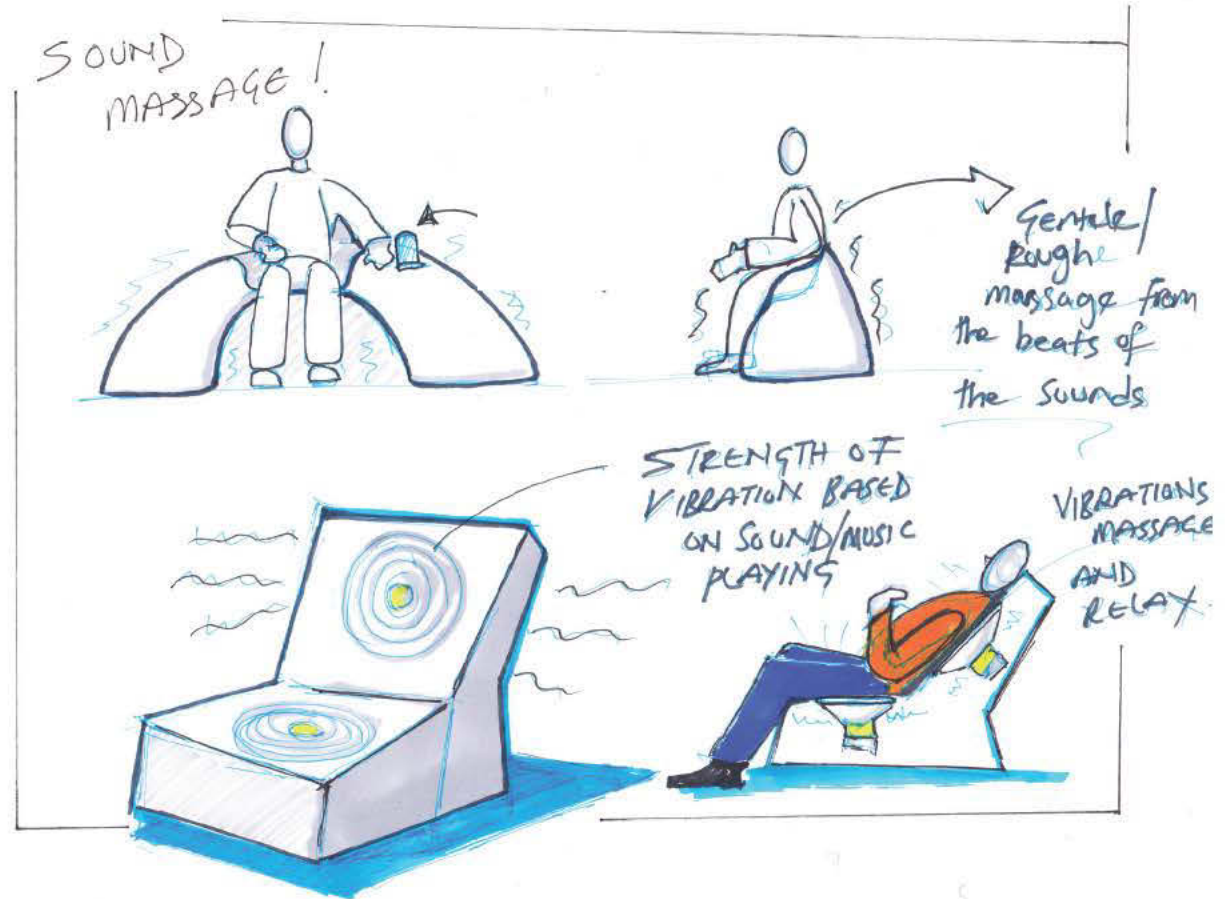

Proposed concepts/ideas.

360

This concept is also in line with bringing people together and encouraging socialising through conversation and sound. The set up consists of chairs in a circular set up, but the chairs move on the circular track and in doing so draw the occupants next to each other. Due to the nature of the design it is possible to be drawn next to each of the occupants of the chair in each direction and so no one is excluded. The system is stationary to start with but moves via a chain-driven motor system to draw one occupied chair to the other. The center of the set up will have a sound-producing system to play various relaxing sounds.

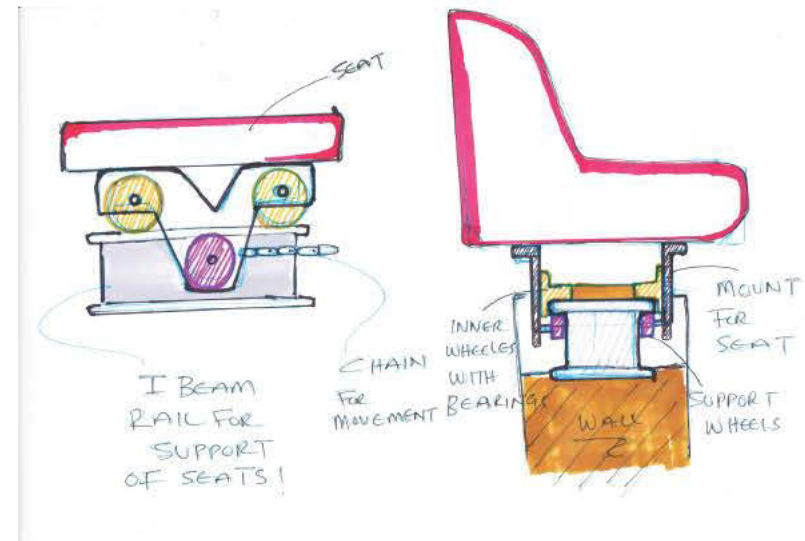
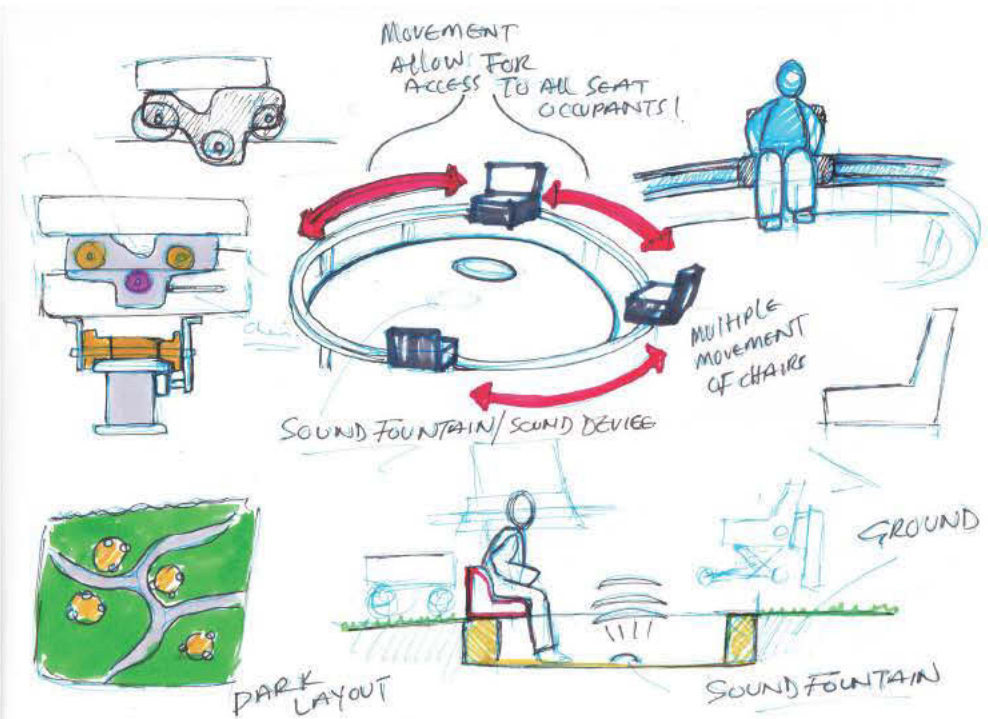
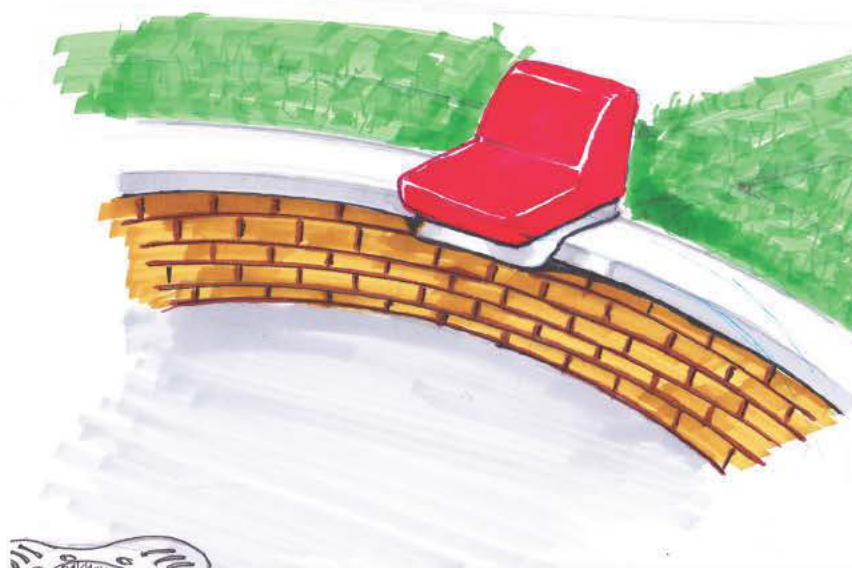

Proposed concepts/ideas.

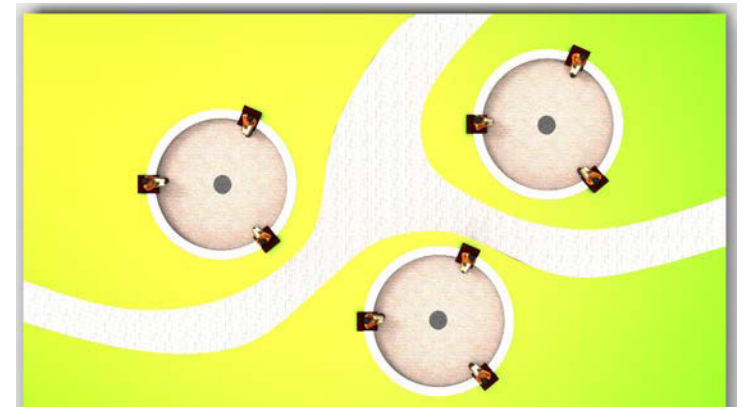
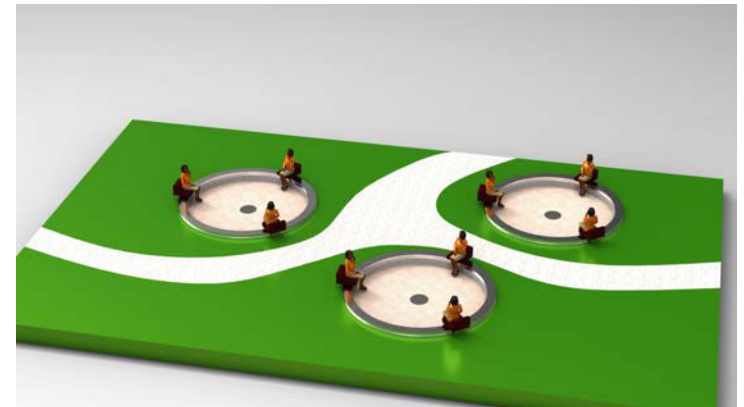

Proposed concepts/ideas.

CONCEPT

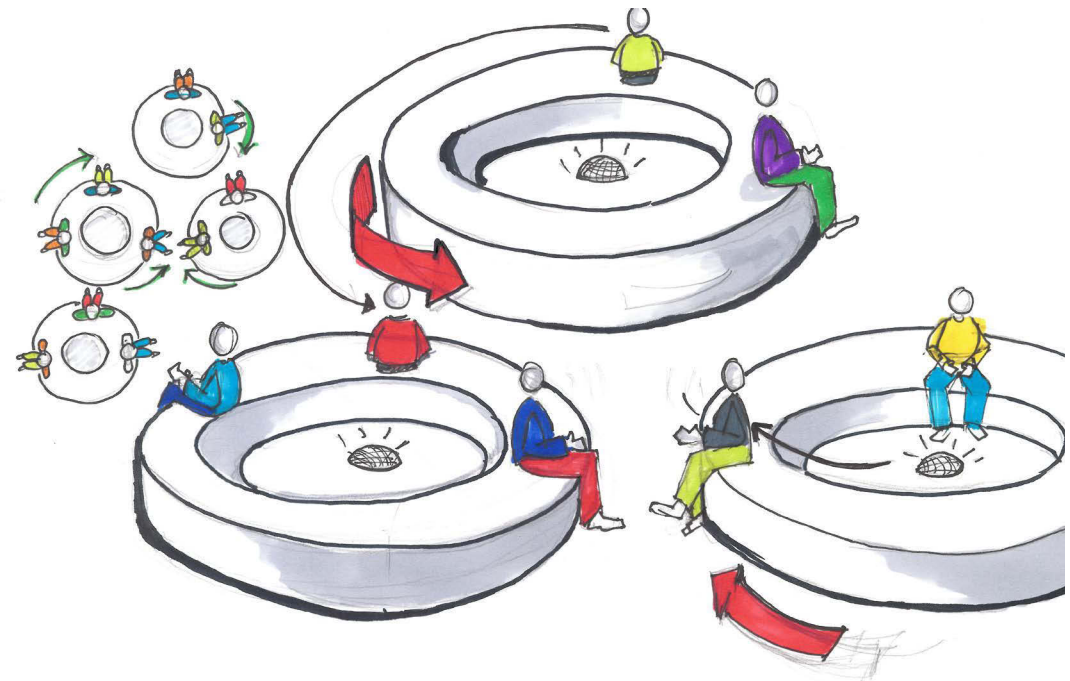
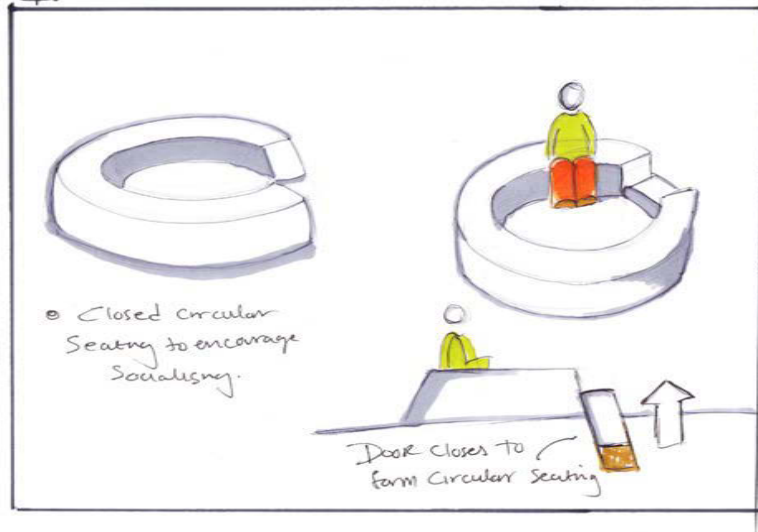

This concept deals with a system of rotating seats which pair up people to enable them to have conversation. The system uses sensors to monitor the positions where the users sit and rotate accordingly to try and pair as many people together as possible for conversation to occur.

Final concept/idea.

The basic thought that comes to mind while looking at the potential sketch ideas and the concept is that the object to be made is based on the concept of having people sit together and socialise through chatting. On their own most people will just introduce themselves in some cases and just remain mute. Whatever be the case though sometime some forced actions can lead to the initiation of further action that had been thought of. Sometimes a little push can initiate actions that bring about social interaction.

The concept of having seating draw people together in a situation where they can mix and actually socialise comes to light. The concept is to have moving seats and to figure out how the seats move. The issue though was to prevent or show signs that the seats do move.

And that the user is in the correct position to seating position. To solve this the seats would have to have a back rest so that user would preferably face forward. The seating position would face forwards also the forward seating position allows the user to be exposed to the sound fountain to arouse his curiosity as to the sounds being produced and where its coming from. This also helps to take his mind of the possibility of

the seat moving.

The next thing was the source of sound, and that came from a sound fountain or basically a speaker system that would play sounds to the air and mimic the sounds of a Water fountain or Birdsong or nature depending on its location and play sounds that soothe and relax the listener.

Ideation.

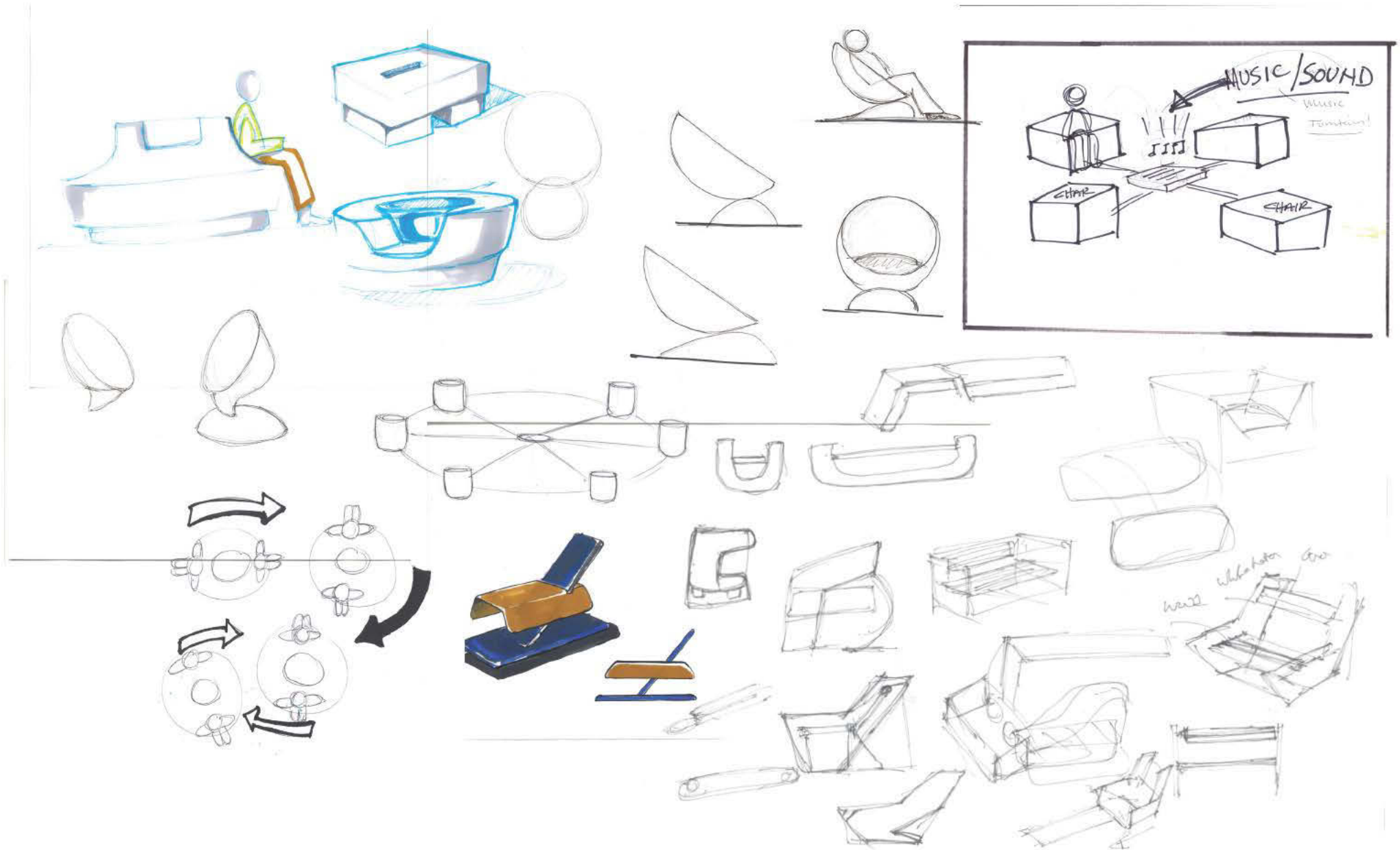

Sketch

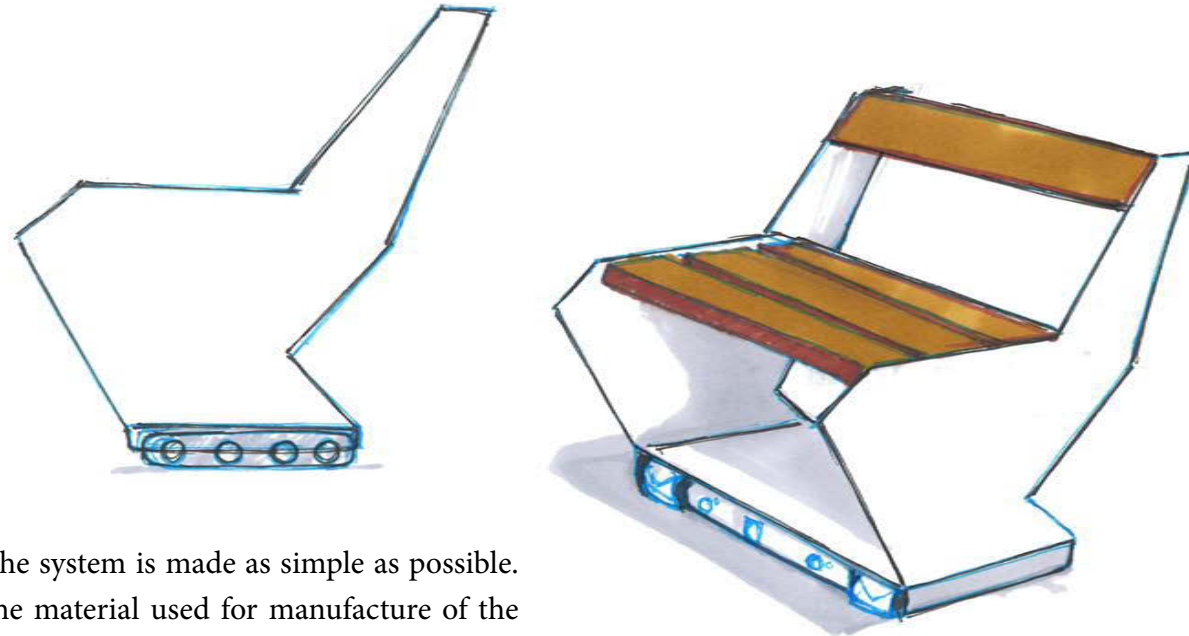

The final design for the seating of the system is made as simple as possible. But there can be variations as to the material used for manufacture of the seating. In this set up re-in for sed aluminium and walnut wood are used. The design makes for durability against the weather and vandals as well as for easy repair and replacement of the component parts. On the whole though the form of the seat is designed to be aesthetically pleasing and attractive as a seat on its own. It is interactive as an object and has the affordance of being seat also makes it easy to know how to use it.

Movement

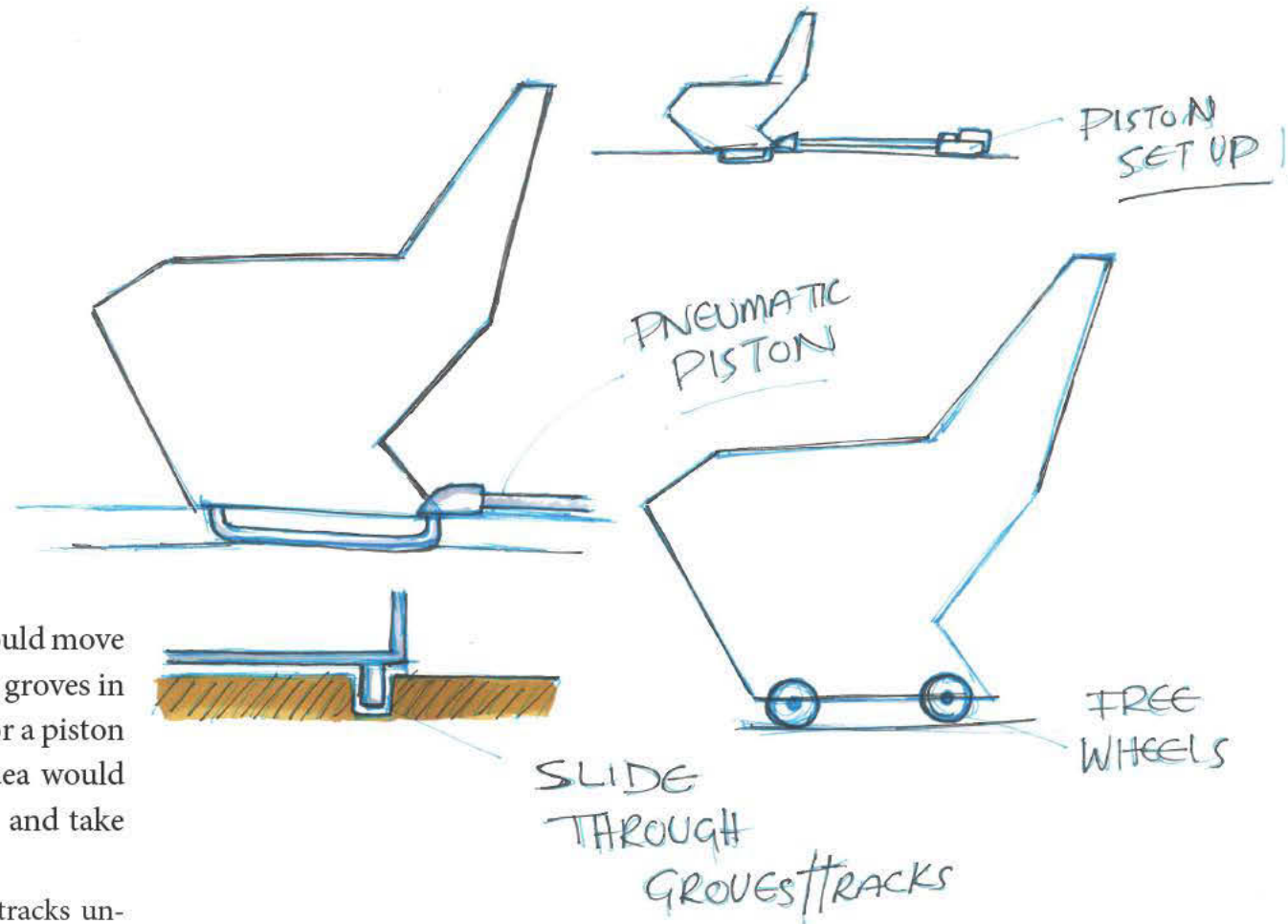

The initial idea for how the seating should move was for it to be pulled or pushed along groves in the dround by hydrolic chain system or a piston from the back of the seats. But this idea would make it obvious that the seats moved and take out the surprise factor.

So the idea of have a swt of moving tracks under the seat which lie flush with the seat and in doin doesnt give away the the concept to the user.

Movement

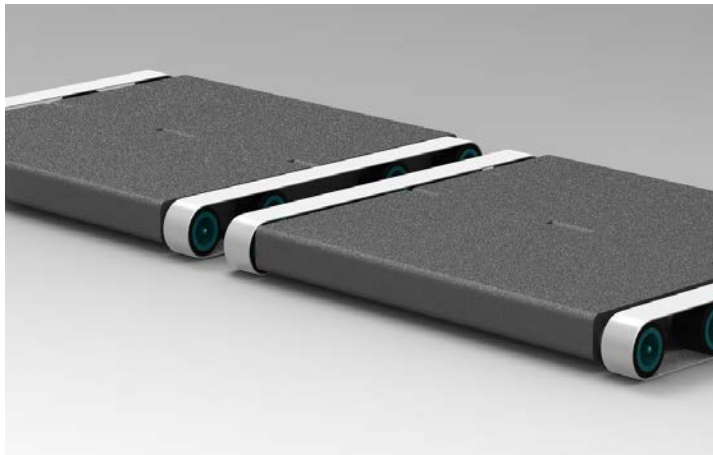
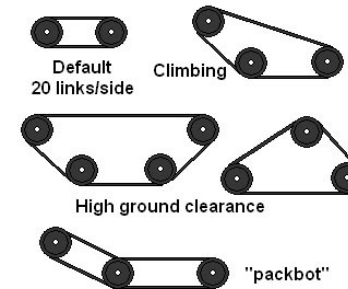
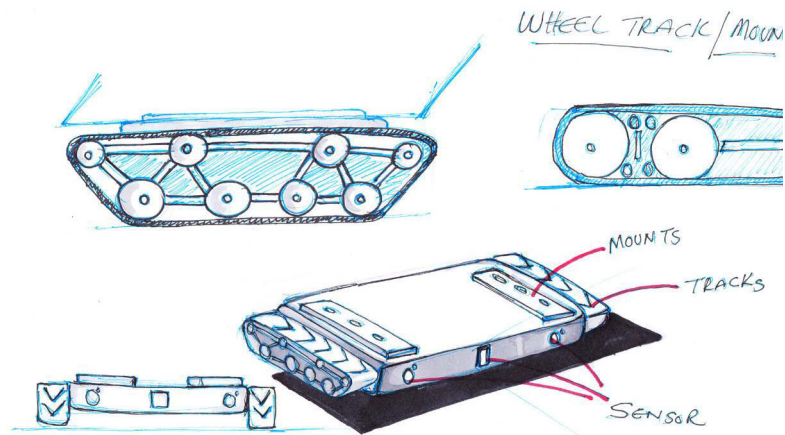

The concept for the movement of the seat is based on the idea of the robot lawn mower, and the robot tracks that allow it to move. They are suitable to be used as they are quiet and flat in nature so they fit under the seating system inconspicuously mounted under the chair they wouldn't be noticed and this adds to the surprise of having what is thought to be stationary move and draw closer together. They are radio controlled and have sensor that see the other seats that are occupied and draw closer to them. They can also be programmed with a set of moments that they can follow when the seats have been occupied. They contain the necessary electronics and will have their power source from batteries which are charged by induction when they reset and return to their original start position.

Proximity

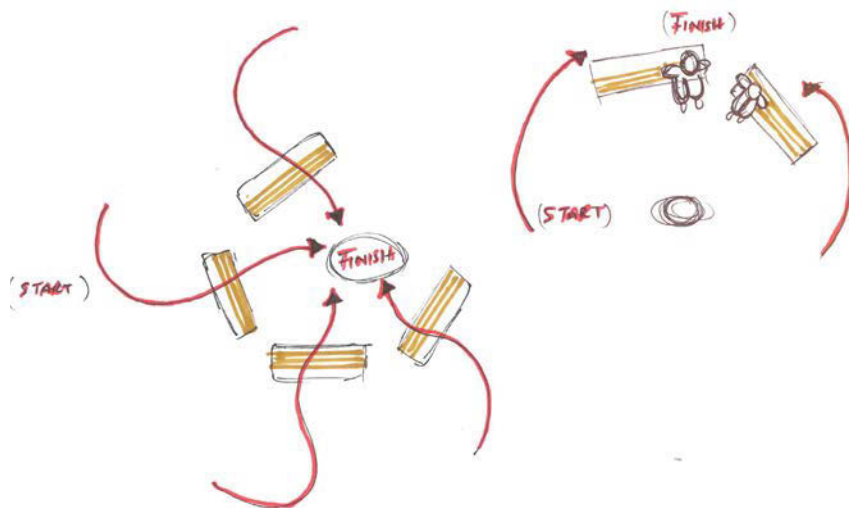

Proximity is an important factor as to determining how close is comfortable for the other person. so the system has built in sensors to ensure that the seats move and position themselves within range of hearing but not too close for comfort. This is especially important in the movement of the seat



Movement of the seats is based on sensors in the unit which detect when the other seats have been occupied and follows move toward the occupied seat.the movement can also be programed to follow a pre-

defined order each time, or they can be free to move in any path. The main objective being to draw closer to another occupied seat and position itself to allow for easy conversation at the appropriate distance.

Proposed concepts/ideas.

Sound fountain

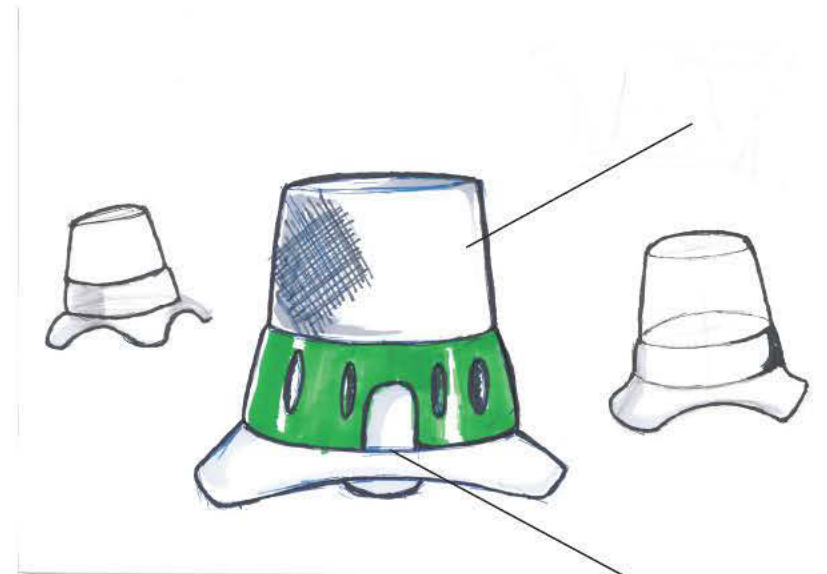
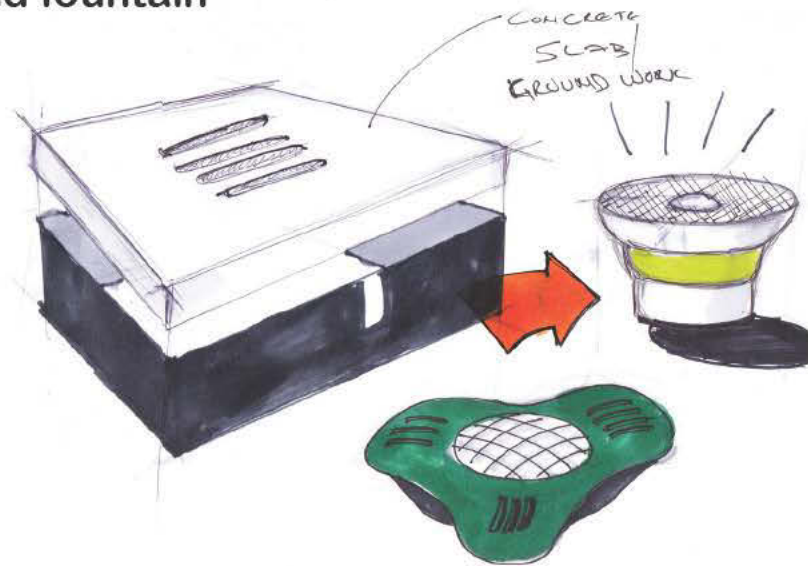

Electronics and control

The sound fountain is a system that is to be designed to be fitted into a seating set up, and to produce sounds or soft music for easy listening and relaxation. The system produces sounds and soft music in the form of soft flowing water or simple soothing birds song depending on where the set up of the seating will be placed. Generally though for the concept of the research design it is to create mimic natural sounds and

soothing notes of water, and nature such as the surf. Since the set up cant be seen in it should spark the curiosity of the people who use the seating set up to think wonder where the soft sound is coming from. The system would incorporate the sound direction speaker technology produces by Woody Norris for a more direct and efficient broad cast of the sounds it produces.

Basic Movement/operation



Start

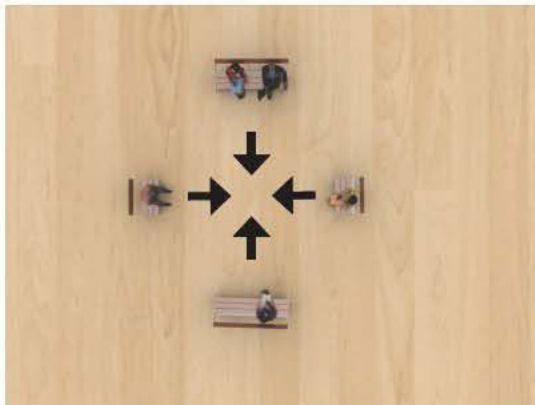

The basic operations starts with the person sitting on the seat which is stationary. The person then enjoys the sounds being produced by the sound fountain in the middle and might read a book in the process. After a specified amount of time the seats would have moved closed to another seat which is being occupied by another person to just the right distance for easy conversation without being too close for comfort. As show in the figures in this case all the seats are occupied and therefore allows for a group conversation to occur after the seats moved closer. The movement can also be preprogrammed to follow appropriate paths, or to scan for other singly occupied seats to draw close to.



Finish

Rendered model of wheels

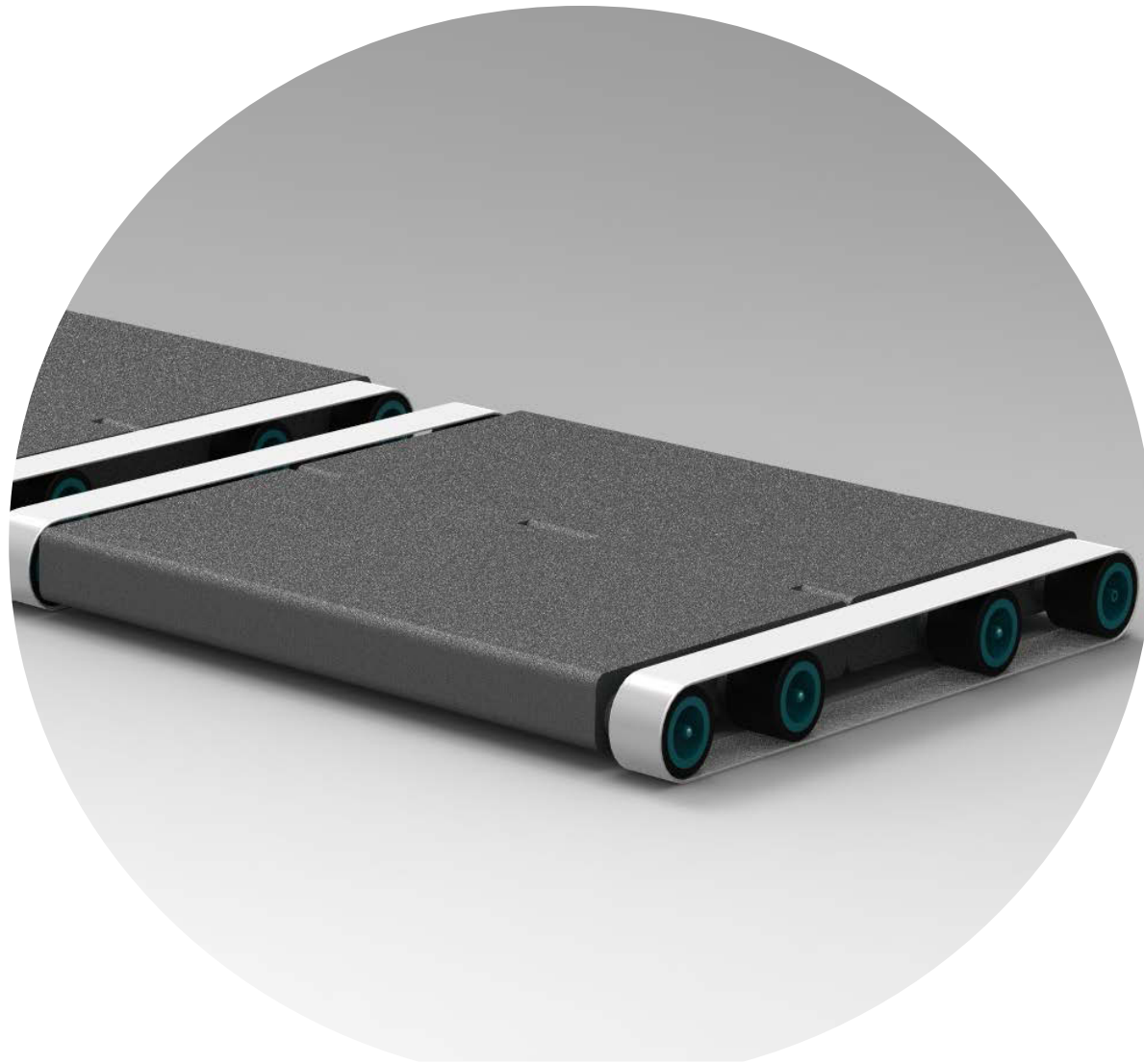

Rendered seat

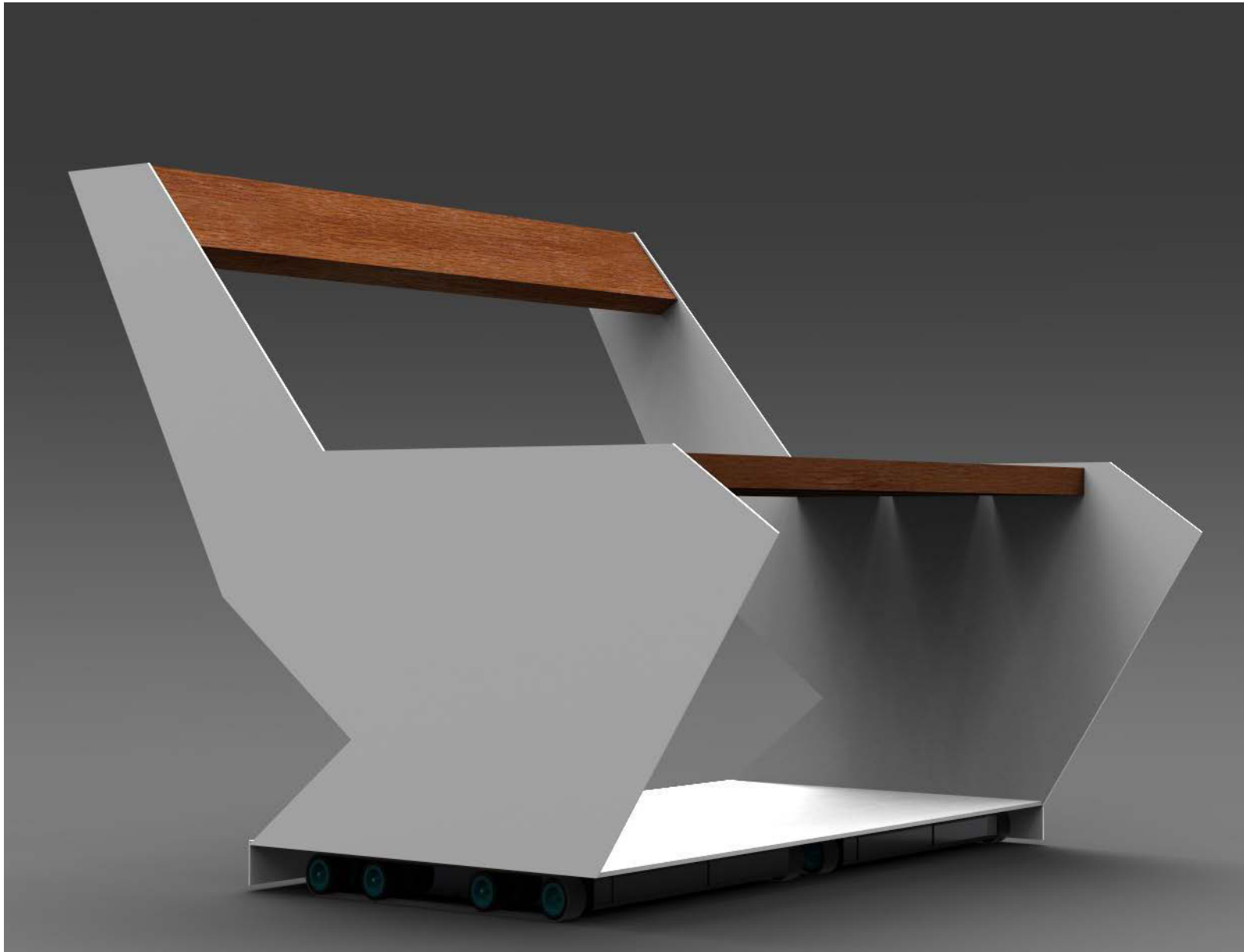

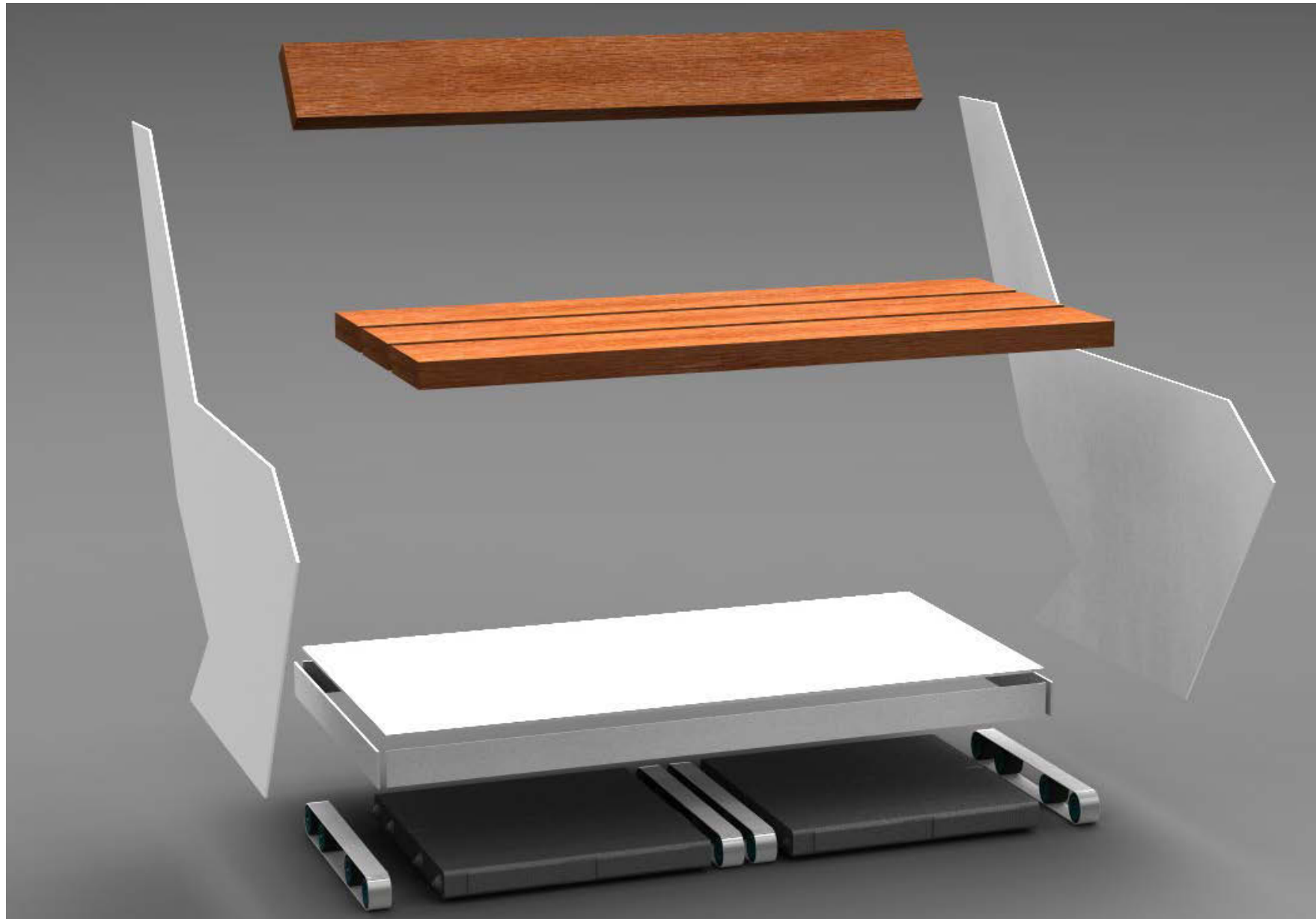

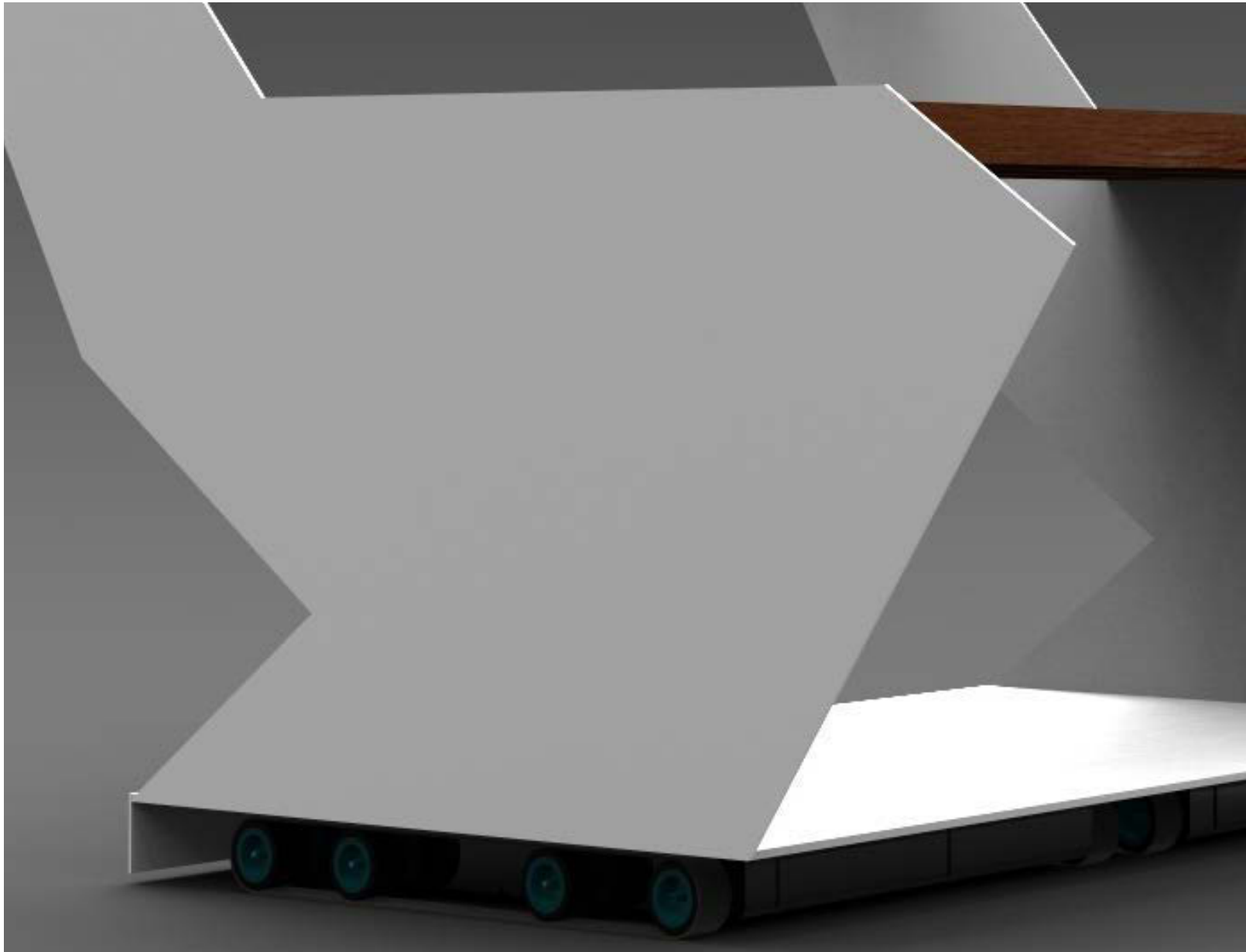





Prototype production.



Prototype production.

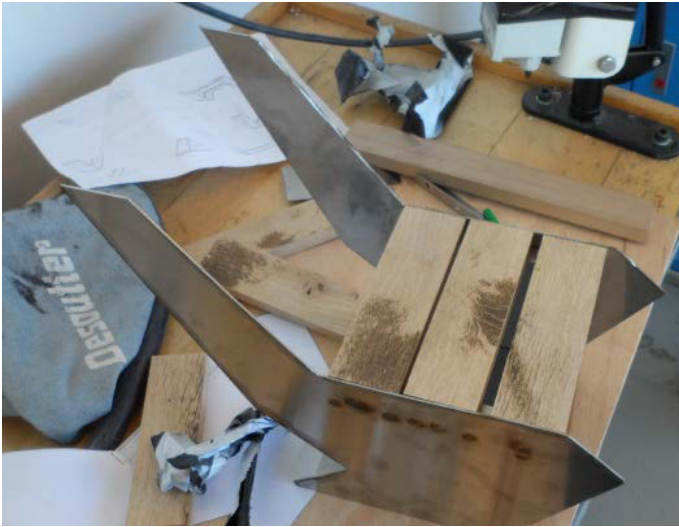

Prototype production.



Prototype production.



Final model/Seat



Final model/ Park set up

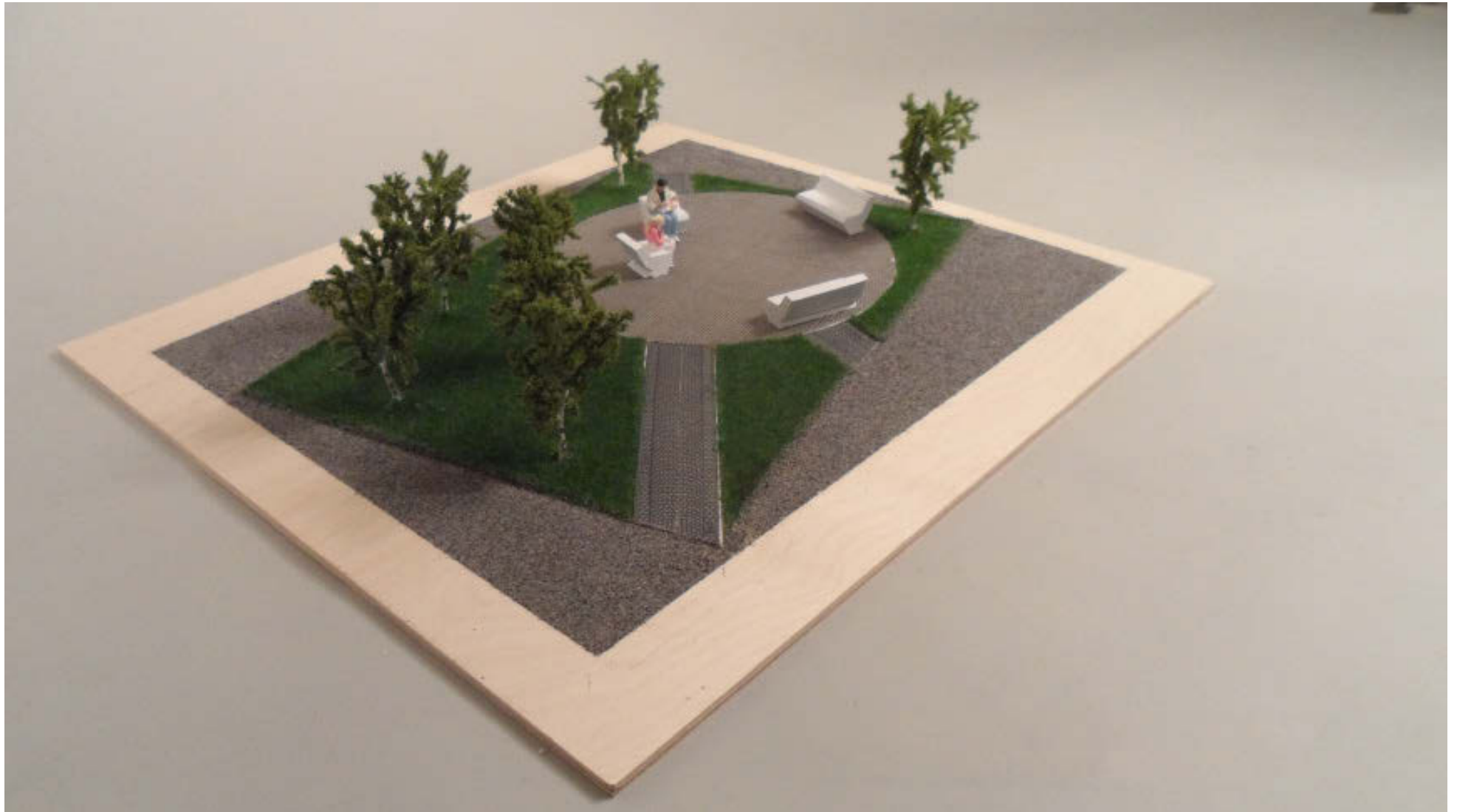

Final set up

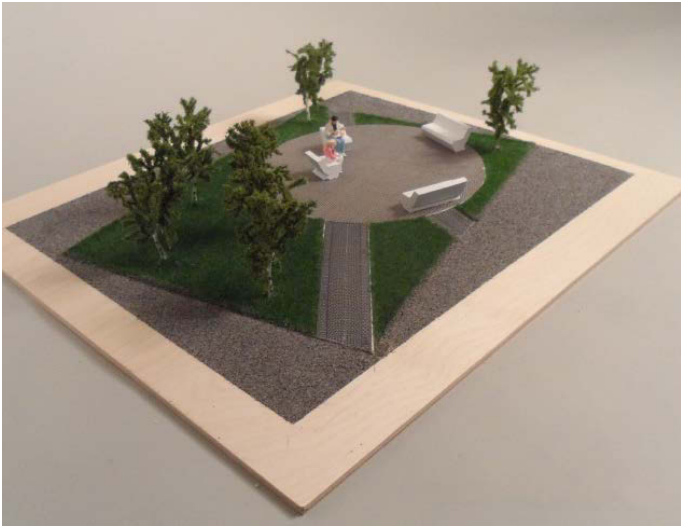

Final up set up



Setup



Setup



Conclusions

The objective of this master thesis was to come up with a product or service which can enhance social interaction through sound. To also provide a report of the research and documentation of the processes involved in the research as well as to provide models or prototypes of the finished product or service design in the process

The outcome of this project are the series of proposed concepts with a final concept being selected as preferred means to answer the research question. The concept at hand being a seating system which is mobile and designed to be both aesthetically beautiful and simple as well as function as part of a system to encourage socialising.

The project is an ongoing project having stemmed from previous work of the student and has more options for further studies. A possible study would be to see the effects of the proposed concept in produced and installed in public. This is to see the results of the proposed concepts and the effects they would have on their users.



Books And papers

**Svanaes, Dag (2011). Philosophy of Interaction. In:
Soegaard, Mads and**

**Dam, Rikke Friis (eds.), Encyclopedia of Human-Computer
Interaction.**

**Aarhus, Denmark: The Interaction-Design.org Foundation.
Available online**

at http://www.interaction-design.org/encyclopedia/philosophy_of_interaction.html.

**Putnam, R. D. (2001), Civic Disengagement in Contemporary
America (The Government and Opposition/Leonard Schapiro
Lecture). Government and
Opposition, 36: 135–156. doi: 10.1111/1477-7053.00059**

<http://www.podcomplex.com/guide/physics.html>

<http://www.dubberly.com/articles/what-is-interaction.html>